

INDICE MOTORES DE ARRANQUE PAGINAS 01 a 92

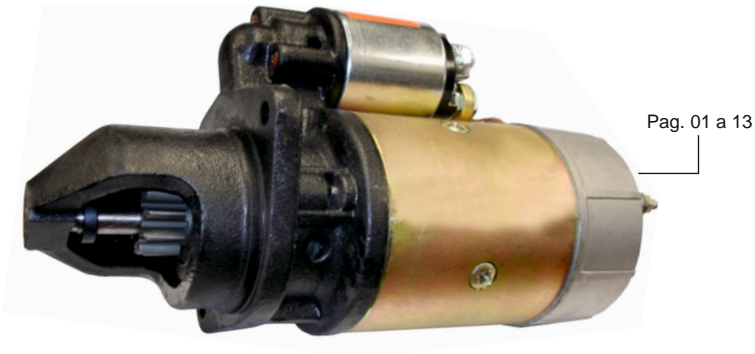

Pag. 82 a 83

Pag. 78

Pag. 79

Pag. 14 a 24

Pag. 82

Pag. 78

Pag. 75 a 77

Pag. 25

Pag. 31 a 32

Pag. 70 a 71

Pag. 67 a 69

Pag. 73

Pag. 83 a 84

Pag. 26

Pag. 31 a 32

Pag. 29 a 30

Pag. 74

Pag. 31

Pag. 71 a 72

Pag. 85

Pag. 89 a 92

Pag. 26

Pag. 78 a 79

Pag. 71

Pag. 24

Pag. 71 a 72

Pag. 85

Pag. 56 a 58

Pag. 78 a 79

Pag. 26

Pag. 24

Pag. 26

Pag. 26

Pag. 32

Pag. 26

Pag. 80 a 82

Pag. 59 a 65

Pag. 27 a 29

Pag. 73

Pag. 33 a 54

Pag. 71 a 72

Pag. 73

ARR. BNG / FKB
Pag. 87 a 88

INDICE PORTAESCOBILLAS

CODIGO	PAG	CODIGO	PAG	CODIGO	PAG	CODIGO	PAG	CODIGO	PAG
P2041	32	P2204/1	33	P2263C	50	P2332/1	39	P2401C	47
P2042	32	P2204C	33	P2264C	34	P2333/1	40	P2402C	49
P2125C	32	P2204C/24	33	P2265C	34	P2333C	40	P2403C	49
P2126C	32	P2205/1	33	P2266C	34	P2334C	40	P2404C	49
P2127C	32	P2205C	33	P2267C	38	P2335C	40	P2405C	43
P2128C	50	P2205CR	33	P2268C	34	P2335C/24	40	P2407C	43
P2129C	50	P2206C	33	P2270C	34	P2336C	35	P2408C	40
P2130	49	P2207C	33	P2271C	46	P2337/1	40	P2408C	45
P2130C	49	P2208C	44	P2272C	34	P2337C	40	P2408C	49
P2131C	38	P2209C	33	P2273C	35	P2338/1	40	P2409C	49
P2132	50	P2210C	43	P2275C	38	P2338C	40	P2410C	36
P2132C	50	P2210C	43	P2276C	42	P2339C	40	P2411C	36
P2133C	32	P2211C	50	P2277C	42	P2340C	52	P2412C	36
P2134C	50	P2212C	33	P2278C	35	P2341C	52	P2413C	36
P2135C	45	P2214C	33	P2279C	45	P2342C	52	P2414C	36
P2136C	38	P2215C	33	P2280C	35	P2343C	45	P2415C	36
P2137C	43	P2216C	44	P2281C	35	P2344C	51	P2416C	36
P2137C	42	P2217C	47	P2282C	35	P2345C	51	P2417C	36
P2138C	38	P2218C	43	P2283C	35	P2347C	46	P2418C	36
P2139C	47	P2218C	43	P2284C	43	P2348C	46/52	P2419C	36
P2140C	32	P2219C	47	P2284C	43	P2349C	46	P2420C	36
P2142C	32	P2220C	50	P2285C	38	P2350C	43	P2421C	36
P2143C	45	P2221C	50	P2286C	51	P2350C	47	P2422C	36
P2144C	32	P2222C	44	P2287C	43	P2351C	43	P2423C	36
P2145C	32	P2223C	41	P2287C	43	P2352C	47	P2424C	36
P2146C	32	P2224C	41	P2288C	43	P2353C	47	P2425C	37
P2147C	32	P2225C	45	P2289C	42	P2354C	47	P2426C	37
P2148C	38	P2226C	45	P2290C	48	P2355C	47	P2427C	37
P2149C	45	P2226C/24	45	P2291C	46	P2363C	48	P2428C	37
P2150C	38	P2227C	33	P2292C	46	P2364C	48	P2429C	37
P2151C	44	P2228C	42	P2293C	51	P2365C	48	P2430C	37
P2151C	53	P2228C	48	P2294C	38	P2366C	48	P2431C	37
P2152C	44	P2229C	53	P2295C	42	P2366C	40	P2432C	37
P2153C	41	P2230C	44	P2296C	39	P2367C	48	P2433C	37
P2154C	38	P2231C	33	P2297C	39	P2368C	48	P2434C	37
P2155C	41	P2232C	45	P2298C	35	P2369C	48	P2435C	45
P2156/1	41	P2233C	33	P2299C	35	P2370C	49	P2438C	37
P2157C	42	P2234C	34	P2301C	35	P2371C	51	P2439C	37
P2158C	42	P2235C	44	P2303C	35	P2373C	51	P2440C	49
P2159C	42	P2236C	34	P2304C	35	P2374C	35	P2441C	37
P2160C	42	P2237C	34	P2308C	41	P2375C	35	P2442C	37
P2161C	42	P2238C	34	P2309C	41	P2376C	41	P2443C	37
P2162C	42	P2239C	45	P2310C	51	P2377C	41	P2444C	38
P2163C	42	P2239C	45	P2311C	48	P2378C	41	P2445C	38
P2165C	52	P2239C/24	45	P2312C	48	P2379C	51	P2446C	49
P2166C	52	P2240C	44	P2313C	44	P2380C	51	P2447C	47
P2167C	50	P2241C	34	P2314C	42	P2381C	51	P2448C	52
P2168/1	50	P2242C	44	P2315C	42	P2382C	51	P2449C	53
P2169/1	49	P2243C	34	P2316/1	39	P2383C	51	P2475C	43
P2169C	50	P2244C	34	P2316C	39	P2384C	51	P2501C	52
P2170/1	50	P2245C	34	P2317C	52	P2385C	51	P2503C	52
P2171/1	50	P2246C	46	P2318C	52	P2386C	51	P2504C	53
P2172C	53	P2247C	46	P2319C	52	P2387C	41	P4080	54
P2173/1	52	P2248C	38	P2320C	39	P2388C	44	P4085	54
P2174C	53	P2249C	38	P2321C	39	P2389C	40	P4107	54
P2175C	53	P2250C	46	P2322/1	39	P2390C	40	P4117	54
P2176C	53	P2251C	48	P2322C	39	P2391C	40	P4117B	54
P2177C	32	P2252C	48	P2323C	39	P2392C	40	P4117BF	54
P2178C	44	P2253C	48	P2324/1	39	P2393C	40	P4117BFI	54
P2179C	44	P2254C	48	P2324C	39	P2394/1	40	P4117BT	54
P2180C	32	P2255C	46	P2324C/24	39	P2395C	43	P4117C	54
P2181C	45	P2256C	46	P2325/1	39	P2395C	43	P4121	54
P2182C	52	P2257C	46	P2326/1	39	P2396C	43	P4121C	54
P2199C	32	P2258C	46	P2327/1	39	P2396C	43	P4122	54
P2201C	33	P2259C	46	P2328/1	39	P2397C	35	P4122C	54
P2202/1	33	P2260C	53	P2329C	46	P2398C	47	P4123	54
P2202C	33	P2261C	34	P2330C	39	P2399C	47	P4124	54
P2203C	33	P2262C	34	P2331C	39	P2400C	47		

CHEVROLET

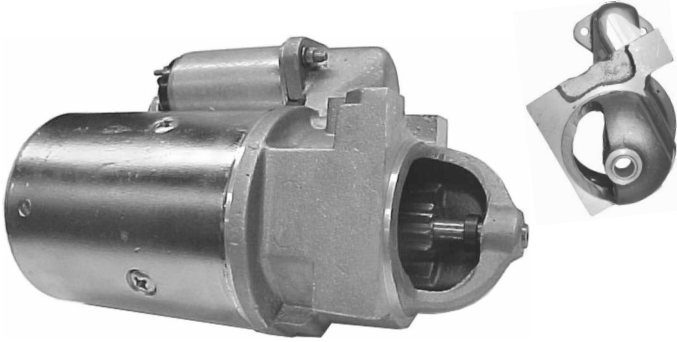

300038
CHEVROLET 400 - PICK UP - OPEL K (35255535)
12V-Z9-Ø25

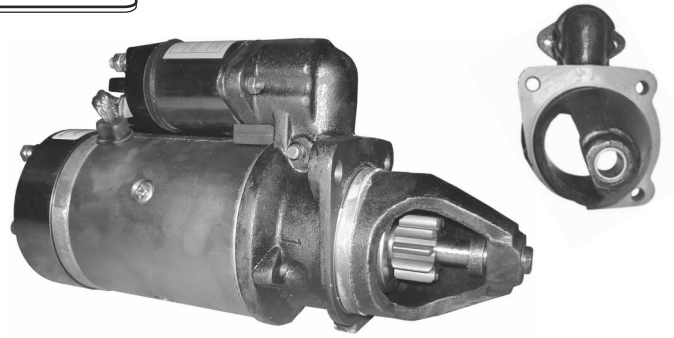

301040
BEDFORD CIMARRÓN CHEVROLET
12V-Z10-Ø40 Reforma AN115
(35256060)

DEUTZ

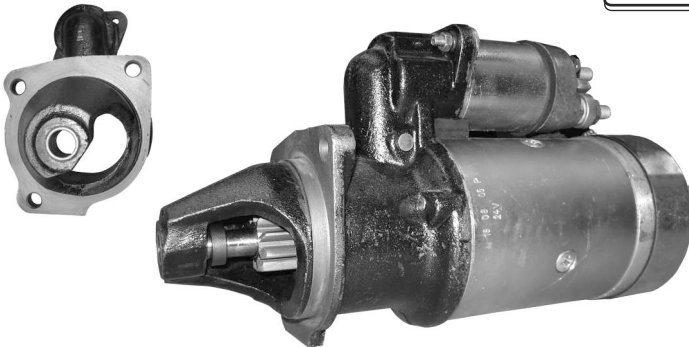

301425
DEUTZ - FAL-A46-A65-MOT. 913
2 Y 3-CILINDROS 12V-Z10-Ø40

301425/24
ÍDEM 24V
301425B
ÍDEM BLINDADO 12V

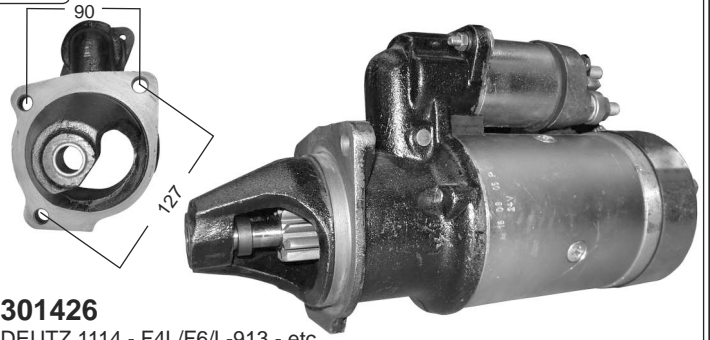

301426
DEUTZ 1114 - F4L/F6/L-913 - etc.
24V-Z9-Ø34,5 (35256954)

301426B
DEUTZ 913 MAQUINA VIAL
(EN BAÑO DE ACEITE)

301426/12
ÍDEM 12V (35256747)
301426B/12
ÍDEM BLINDADO 12V



301427
DEUTZ - FHAR 70/85/86
24V-Z9-Ø34,5 - AN115

301427/12
ÍDEM 12V

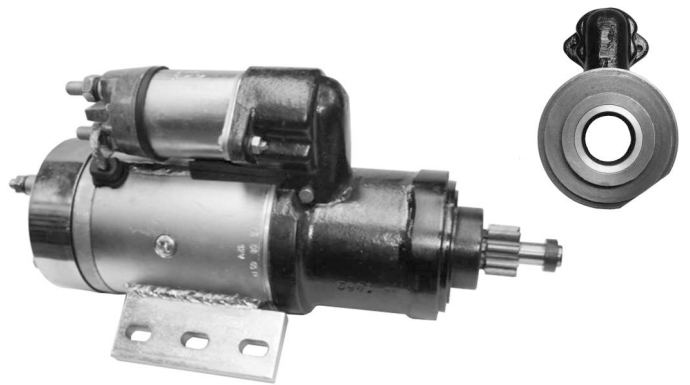

301430
DEUTZ DA130-144-514 MOTOR 1113-2114
24V-Z9-Ø34,5 (REEMPLAZO ARR. BNG. C/SUNCHO)



301469
DEUTZ A40-45-55-65 (REEMPLAZO ARR. BNG)
12V-Z9-Ø34,5
301469/10
DEUTZ A40-50 12V-Z10-Ø38,5
301469/11
DEUTZ 50-IMP 12V-Z11-Ø40,8

301469/24
301469/10/24
301469/11/24
ÍDEM 24V

VW / DODGE



301380
CAMION VOLKSWAGEN 13180 TIPO INDIEL 12V. Z10 Ø38,5MM.



301704
DODGE PICK UP D100 - D200 - etc. 12V. - Z9 - Ø25

FIAT

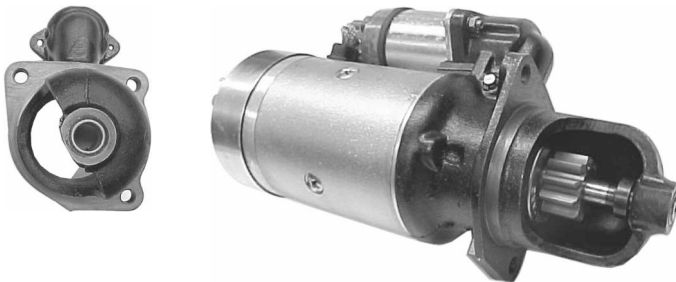

300322
FIAT 673-900-1100 - MOTOR CP3-24V-Z10-Ø40
(35256320)

300322/12
ÍDEM 12V

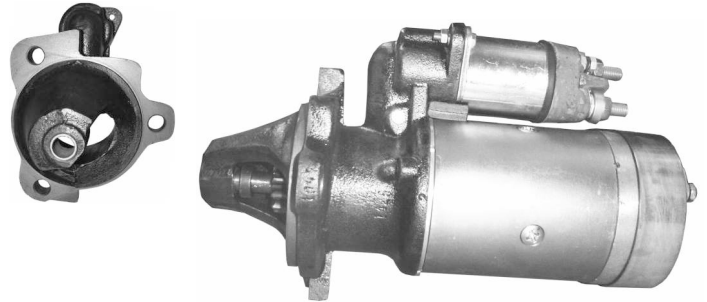

301047
FIAT 619 - Reemp. arranque FKB
24V Z11 Ø40,8 - Ref. DIPRA

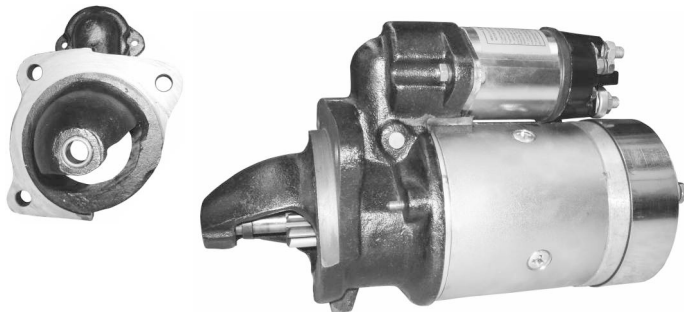

301048
TRACTOR FIAT 540-640-880-980
NEW HOLLAND -12V - Z9 - Ø34,5

301048/24
ÍDEM 24V



301056
FIAT 619 N1 y 697 - Reemp.M.MARELLI 24V Z11 - Ø40,8 Ref. DIPRA

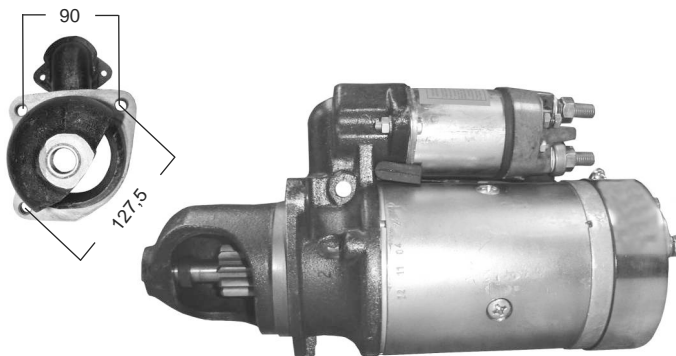

301468
FIAT 900 - CAMIÓN 713 - TRACTOR 800E/900E
12V-Z10-Ø40

301468/24
ÍDEM 24V



301469/10
FIAT 400-500-etc - DEUTZ 55 - Reemplazo BNG - CAV - 12V-Z10-Ø38,5

FIAT

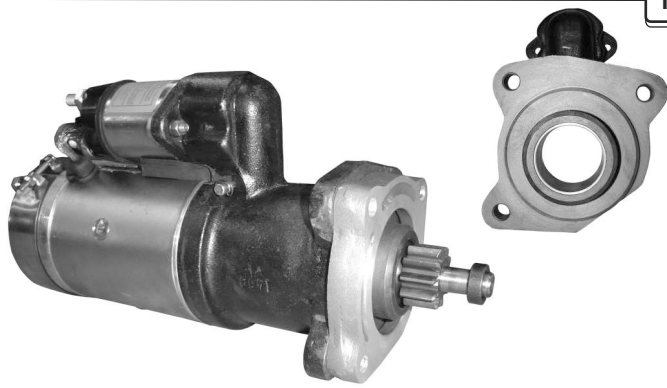

301469I
FIAT 650-700 / Reemp. CAV GIRO IZQ. 12V-Z10-Ø38,5 - Ref. AN115



301470
FIAT SOMECA - 450 12V-Z9-Ø34,5 Reemp. BNG c/suncho - Ref. AN115

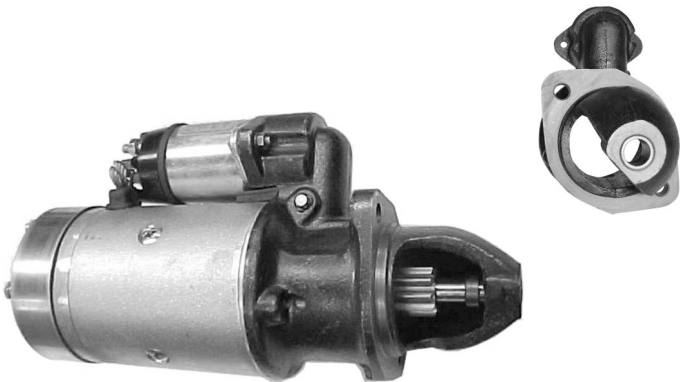

301471
FIAT U25 - GIRO IZQUIERDO 12V-Z9-Ø34,5

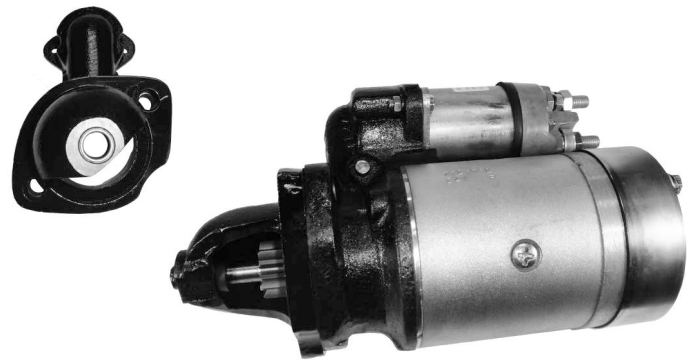

301472
FIAT 411-24V-Z9-Ø35

301472/12
ÍDEM 12V



301473
FIAT TRACTOR 400-500-600-700 12V-Z10-Ø40 (35256459)



301474
FIAT 150 TURBO 24V-Z9-Ø34,5 (FC 115024) - T. BOSCH



301476
FIAT EUROCARGO - EUROTRAKKER 24V-Z9-Ø34,5 - T. BOSCH



301477
FIAT IVECO - DAILY - 12V-Z9-Ø34,5 - T. BOSCH

FIAT

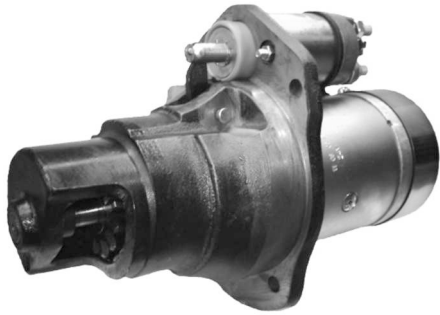
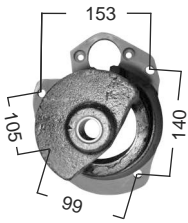

301780
FIAT 780 24V-Z12-Ø57,5
HELICOIDAL
301780/12
ÍDEM 301780 12V

301780R
FIAT 780-R60 24V-Ø57,5
Z17 DIENTES RECTOS
301780R/12
ÍDEM 301780R 12V

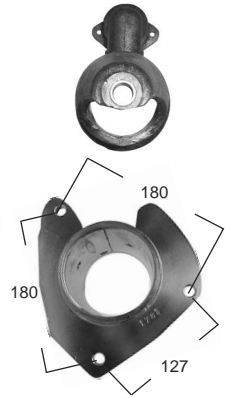
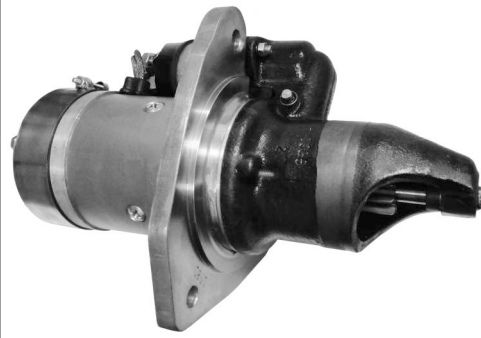

301781
FIAT 780 - Reemplazo BNG c/suncho
24V-Z9-Ø34,5

301781/12
ÍDEM 12V

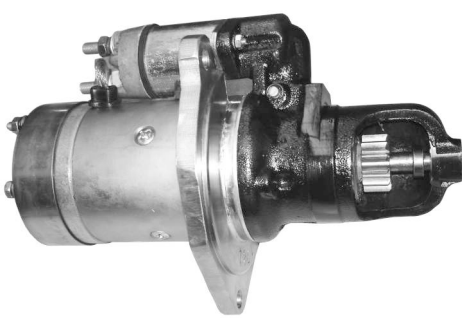

301782
FIAT 780/650 - Reemplazo M.MARELL
c/suncho 24V-Z12-Ø43,5
301782/12
ÍDEM 12V

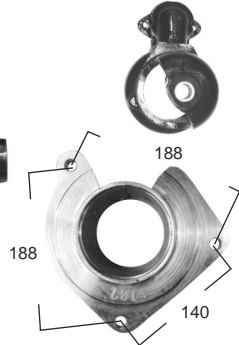

301783
FIAT 780 Reemplazo BPD
24V-Z11-Ø40,8



301784
FIAT 780 - REEMP. BNG - 24V-Z9-Ø34,5 ESPECIAL

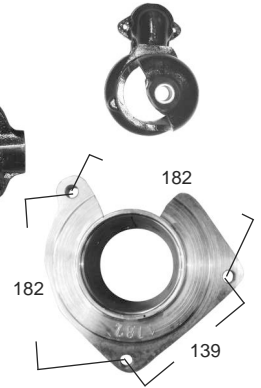

301784/12
ÍDEM 12V

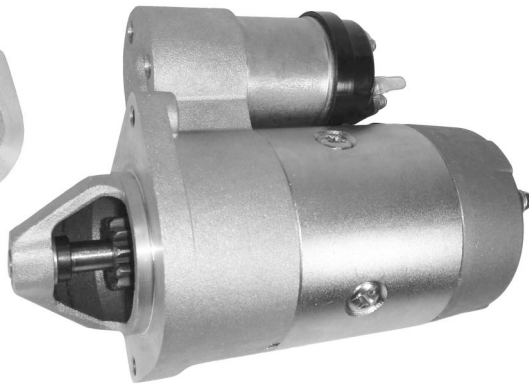

301892
FIAT DUNA 1.4 - 1.6 TIPO INDIEL M93 - 12V-Z11-Ø29,5

FORD



301164
FORD FALCON MODELO VIEJO 12V-Z9-Ø29.5 (35256303)

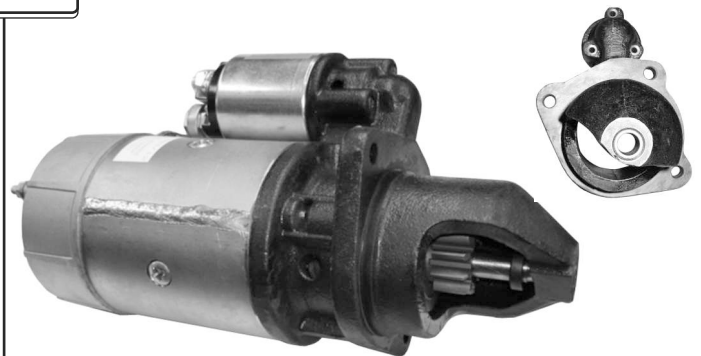

301166
FORD F350 - F4000 - CARGO 7000
MOTOR CUMMINS 4BT-6BT-AA - 12V-Z10-Ø32

FORD



301167

FORD 3500/4000/7000/14000 (35258240)
MOTOR MWM - 12V-Z9-Ø34,5

301167B

ÍDEM BLINDADO



301240

CAMIÓN FORD 7000 (35256422)
MOTOR PERKINS 6-354 - 12V-Z10-Ø40

301240/24

ÍDEM 24V



301305

FORD CAMIÓN Y PICK-UP (35256425)
MOTOR PERKINS 4-203 / 6-305
12V-Z10-Ø40

301305B

ÍDEM BLINDADO

301305/24

ÍDEM 301305 24V



301305C

FORD PICK-UP - MOTOR PERKINS 4-203
12V-Z10-Ø40 CORTO

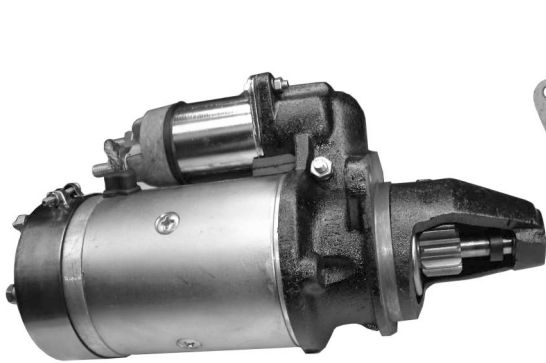

301306

FORD 14000 - MOTOR PERKINS - 12V-Z9-Ø34,5

IKA RENAULT

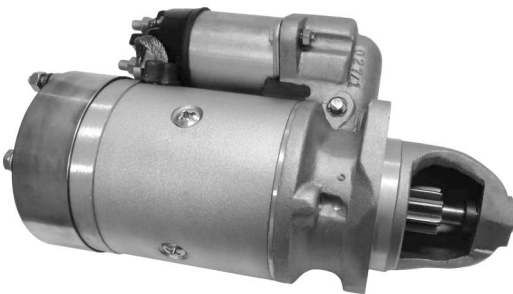

301027

AUTOELEVADOR MOTOR CONTINENTAL
12V-Z9-Ø29 - Reforma DIPRA



301027B

AUTOELEVADOR MOTOR CONTINENTAL BLINDADO
C/EMBRAGUE EN BAÑO DE ACEITE - 12V-Z9-Ø29 - Reforma DIPRA

IKA RENAULT



301027D
 AUTOELEVADOR MOTOR CONTINENTAL
 12V-Z9-Ø29 - Reforma DIPRA



301027JE
 JEEP - ESTANCIERA - RAMBLER - ETC
 MOTOR CONTINENTAL 12V-Z9-Ø29

JOHN DEERE



301068
 J.DEERE 1420-2030-2144-2333-2420-2530-2730-3140
 12V-Z10-Ø32

LINEA ASIATICA

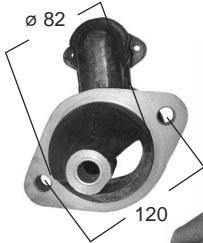

301049
 CAMIÓN 3 STAR - YUEJIN - LYDON
 24V-Z11-Ø39,5 (Diámetro de encastre 82mm)



301049/12 ÍDEM 12V
301055
 CAMIÓN SANXING 24V-Z9-Ø35,5
 (Diámetro de encastre 95mm) - Reforma AN115-BLACK

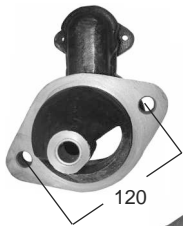

301067
 CAMIÓN JAC-JIMBEI (mecánica ISUZU)
 24V-Z11-Ø39,5 (Diámetro de encastre 82mm)
 Ref. AN115

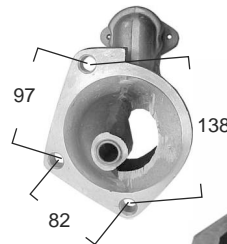

301067/12 ÍDEM 12V
301069
 CAMIÓN NISSAN CPC14-MOTOR 6 CILINDROS
 24V-Z11-Ø39,5 (Ref. DIPRA)

MERCEDES BENZ

 <p>301307 M.BENZ 608 - DEUTZ - 12V-Z9-Ø34,5 - INDIEL</p>	 <p>301383 M.BENZ TIPO BOSCH JF 12V-Z9-Ø34,5 (9 000 083 054)</p> <p>301383/24 ÍDEM 24V</p>
 <p>301384 M.BENZ 712 ELECTRÓNICO Reemplazo DELCO-REMY 24V-Z9-Ø34,5</p>	 <p>301385 M.BENZ 608 - 12V-Z9-Ø34,5 TIPO BOSCH (9 000 083 064)</p>
 <p>301469 M.BENZ - TODOS - Ref. DIPRA Reemplazo MOTOR BNG - 12V-Z9-Ø34,5</p>	 <p>301649 M.BENZ 608/1518 12V-Z9-Ø34,5 (35257385)</p> <p>301469/24 ÍDEM 24V</p> <p>301649/24 ÍDEM 24V</p>
 <p>301650 M.BENZ SUPER TORQUE 1633/1634/1638 24V-Z12-Ø46 - Ref. AN115</p>	

MITSUBISHI

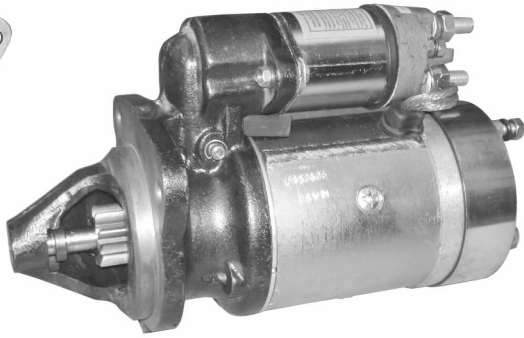

301050
MITSUBISHI CANTER - 24V-Z9-Ø35
Reforma AN115



301051
AUTOELEVADOR MITSUBISHI
NAFTERO 12V-Z10-Ø31,5

301051/8
ÍDEM 12V-Z8-Ø28
301051/11
ÍDEM 12V-Z11-Ø34,5

MOT. CUMMINS / REFORMA DIPRA

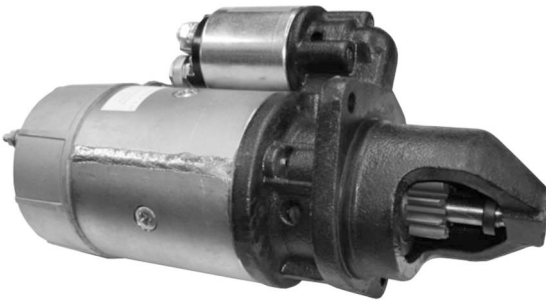

301166
FORD F350 - F4000 - CARGO 7000
MOTOR CUMMINS 4BT-6BT-AA - 12V-Z10-Ø32

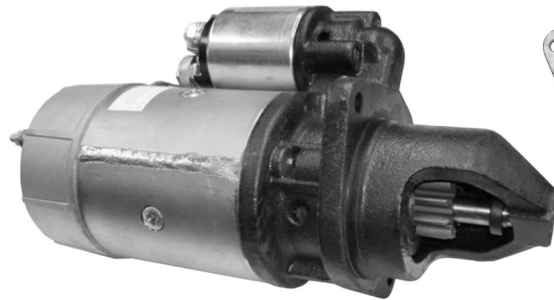

301388
MICRO OA 106 - CUMMINS 4BT-4BTT-6BT-6BTAA
24V-Z10-Ø32

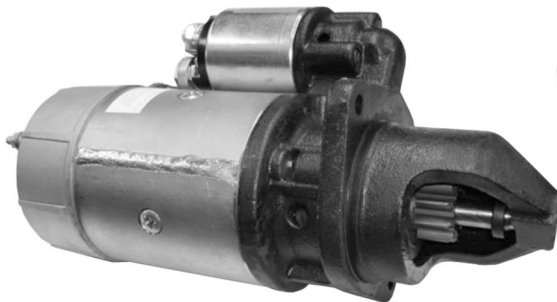

301389
TRACTOR ZANELLO - MOT. CUMMINS
12V-Z10-Ø40

301389/24
ÍDEM 24V



301390/24
CAMION VW 15-160 MOTOR CUMMINS 24V.

MOT. PERKINS / REFORMA DIPRA



301240
CAMIÓN FORD 7000 (35256422)
MOTOR PERKINS 6-354 - 12V-Z10-Ø40

301240/24
ÍDEM 24V



301305
FORD CAMIÓN Y PICK-UP (35256425)
MOTOR PERKINS 4-203 / 6-305
12V-Z10-Ø40

301305B
ÍDEM BLINDADO
301305/24
ÍDEM 301305 24V

MOT. PERKINS / REFORMA DIPRA

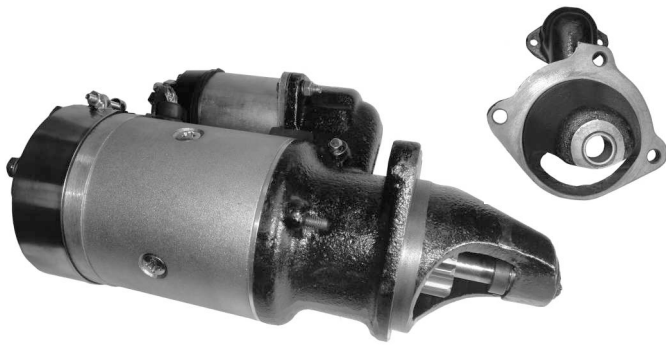

301305C
PERKINS 4-203 (CORTO)

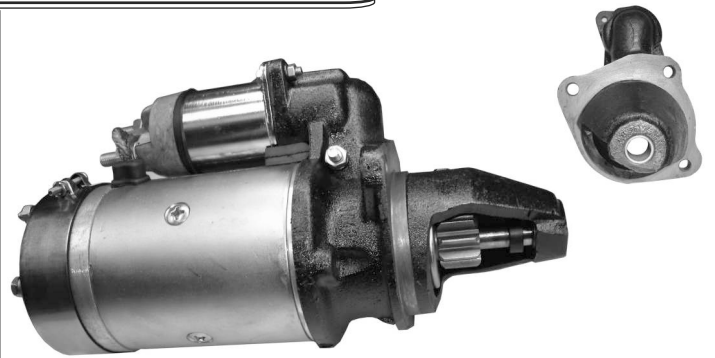

301306
FORD 14000 - MOTOR PERKINS - 12V-Z9-Ø34,5

MOT. VARIOS / REFORMA DIPRA



301060
REEMPLAZO ARR. DELCO-REMY - MÁQUINAS VIALES, ETC.
24V-Z12-Ø46 - Ref. DIPRA



301469
DEUTZ A40-45-55-65 (REEMPLAZO ARR. BNG)
12V-Z9-Ø34,5

301469/24
ÍDEM 24V



301469/10
DEUTZ A40-50 (REEMPLAZO ARR. BNG)
12V-Z10-Ø38,5

301469/10/24
ÍDEM 24V



301469/11
DEUTZ 50 (REEMPLAZO ARR. BNG)
12V-Z11-Ø40,8

301469/11/24
ÍDEM 24V

NISSAN

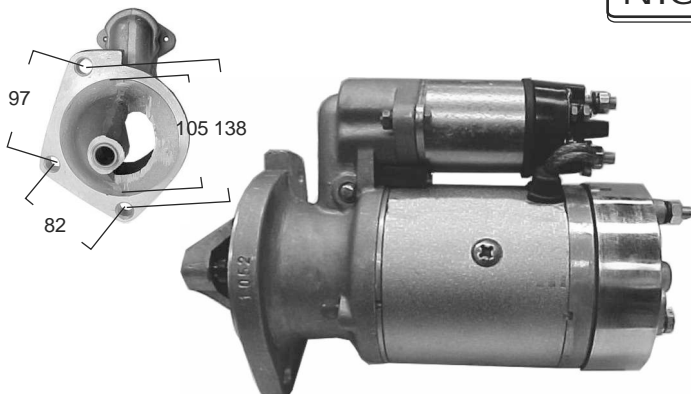

301052
NISSAN LD30/33 - MOTOR 4 y 6 CIL.
24V-Z10-Ø38,5 - Ref. AN115

301052/12
ÍDEM 12V



301069
CAMIÓN NISSAN CPC 14- MOTOR 6CIL.
DODGE MOTOR NISSAN LD30
24V-Z11-Ø39,5 - Ref. AN115

301069/12
ÍDEM 12V

PEUGEOT



300160/4
PEUGEOT DIESEL LIGERO XD2
12V-Z10-Ø27 (35257700)

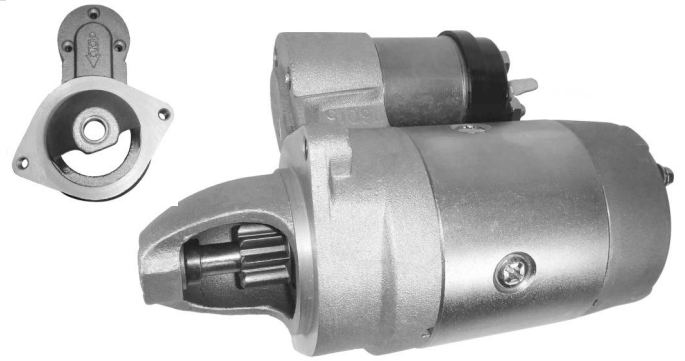

300160/5
PEUGEOT 504 - 505 FRONTAL - 12V-Z9-Ø25,5

RASTROJERO



300106/1
RASTROJERO - MOT. BORGWARD
12V-Z9-Ø34,5 - Ref. AN115

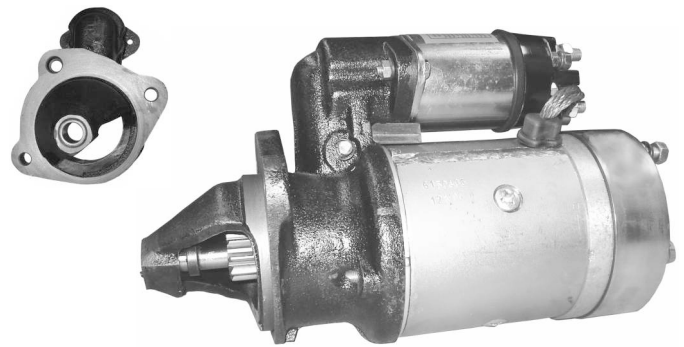

300106/2
RASTROJERO - MOT. INDENOR 12V-Z9-Ø29 - Ref. AN115

RENAULT



301159
RENAULT TRAFIC DIESEL - RENAULT 18 DIESEL
Ref. tipo INDIEL - REEMPLAZO ARR.VALEO 12V-Z12-Ø27 (35257880)



301161
RENAULT 6/12/18 MOTOR 1400CC T. INDIEL M93
12V-Z9-Ø25

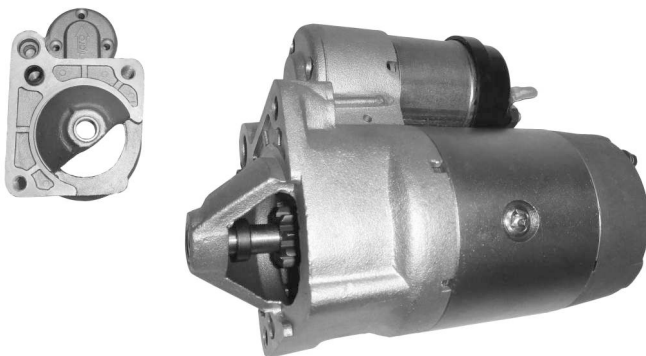

301163
RENAULT 9, 11, 12, 18 Y 19 MOTOR 1600 CC
12V-Z9-Ø25



301184
RENAULT 18 NAFTERO MOTOR 2000 T. INDIEL M93
12V-Z9-Ø25

SCANIA



301054
SCANIA CAMION 24V-Z11-Ø40,8



301386
SCANIA 220 - MOT. P93-P94 - 24V-Z9-Ø34,5

TATA

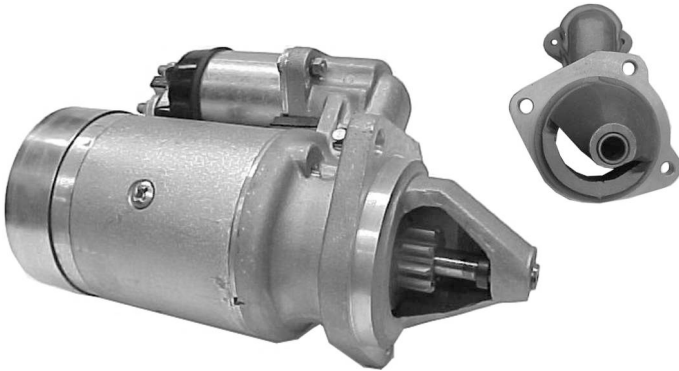

301066
CAMIÓN TATA - 12V-Z9-Ø34,5 - Ref. AN115

TOYOTA

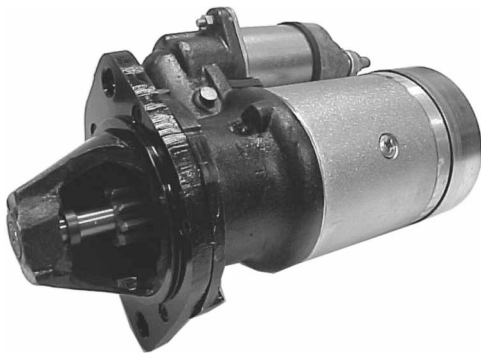
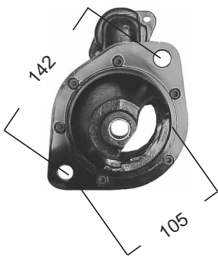

301057
TOYOTA 24V-Z9-Ø34,5 - Ref. AN115

AGUJERO ROSCADO

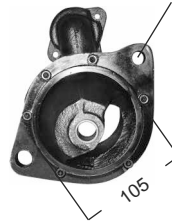

301058
TOYOTA MOT. DYNA REEMPLAZO ARR.
NIPPONDENSO 24V-Z11-Ø40 - Ref. AN115

TRACTORES

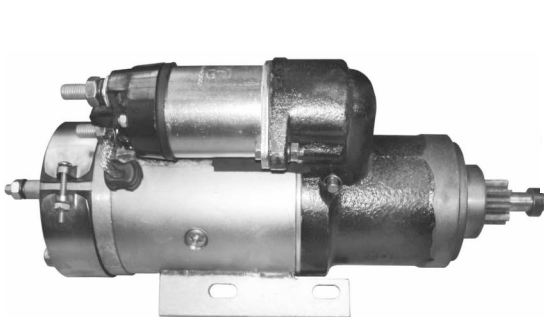

301043
TRACTOR HANOMAG 55
LADO DERECHO ENCASTRE Ø57
12V-Z9-Ø34,5



301044
TRACTOR HANOMAG 33/35
ENCASTRE Ø62 - 12V-Z9-Ø34,5
Ref. DIPRA

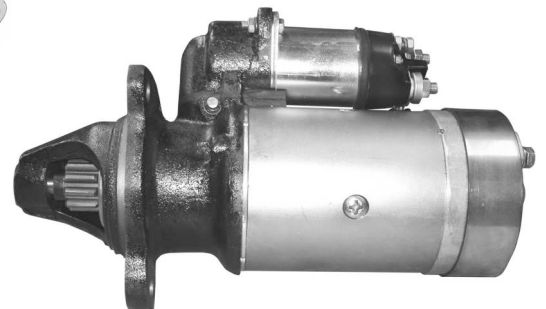

301045
TRACTOR BELARUZ 12V-Z10-Ø36

TRACTORES



301046
TRACTOR RUSLAN - MOT. RUSO 2 y 4CIL.
12V-Z10-Ø36



301048
TRACTOR UNIVERSAL FIAT 540-640-980
12V-Z9-Ø34,5



301048/24
ÍDEM 24V

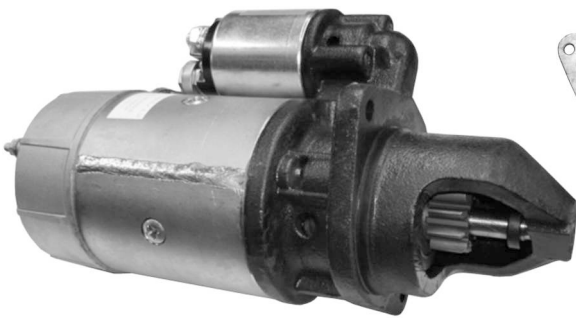

301389
TRACTOR ZANELLO - MOT. CUMMINS
12V-Z10-Ø40



301389/24
ÍDEM 24V



302265/12
TRACTOR ZETOR 12V.



MOTORES ESPECIALES

- 301000:** PERKINS INGLES 3 CILINDROS
- 301041/2:** CHEVROLET C10 MOT. PERKINS (BRASIL) 12V. Z10 Ø40
- 301052/9:** NISSAN ED30-33 Z9 Ø36 12V.
- 301062:** PERKINS INDUSTRIAL 12V.
- 301070:** AUTOELEVADOR MITSUBISHI 12V.. BLINDADO
- 301071:** TRACTOR M. FERGUSSON 4 CIL.,. 12V. Z9
- 301077:** AUTOELEVADOR DAEWOO L-1834T E1 24V.
- 301079:** PALA RETROEXCAVADORA 24V. Z11 Ø53
- 301083:** PALA MICHIGAN 12V. Z10 Ø40
- 301481:** NEW HOLLAND CON MOTOR FIAT
- 302260:** MAQUINA VIAL AN115 24V. Z10 Ø47
- 302262:** REFORMA PALA CHINA 4 CILINDROS
- 302263:** AUTOELEVADOR REEMPLAZO DELCO REMY, MOTOR CONTINENTAL
- 302264:** CAMIONETA DATSUN MOTOR NISSAN L18 NAFTA
- 302266:** CAMION CHINO YANGZULANG Z12 Ø42,3
- 302267:** ESTACIONARIO CIASA 232CM. GIRO IZQUIERDO
- 302269:** AUTOELEVADOR NISSAN 4 CILINDROS SD25
- 302270:** MOTOR ARRANQUE ESPECIALTRACTOR FAHR MOTOR MERCEDES BENZ 2 CILINDROS TIPO D 215
- 302271:** MOTOR ARRANQUE ESPECIALPALA CARGADORA XCMG ZL306 6 CILINDROS CHINA 24V.
- 302272:** MERCUISER 6 CIL. 180 HP. DIESEL
- 302273:** AUTOELEVADOR WAUKESHA NAFTERO A GAS
- 302275:** AUTOELEVADOR KOMATSU Z9 Ø32,5 12V.
- 302276:** FIAT R60 24V.
- 302277:** MOTOCOMPRESOR MERCEDES BENZ 6 CILINDROS 24V.

MOTORES ESPECIALES

- 302279:** NISSAN AUTOELEVADOR KOMATSU 12V.
- 302280:** MAHINDRA 12V.
- 302282:** CAMION CHINO YUEJING
- 302283:** MAQUINA RETROEX. ALLIS CHALMERS MOT. PERKINS 140-6 CIL. INGLES
- 302284:** CAMION FORD MOTOR CUMMINS 24V. Z12
- 302286:** COSECHADORA NEW HOLLAND MOTOR FORD GENESIS 12V.
- 302287:** JOHN DEERE MOTOR PERKINS CHILENO 12V.
- 302288:** PALA CHINA XCMG MOD. W166 AÑO 2009 Z9 24V.
- 302290:** TRACTOR JONH DEERE 2000 MOTOR 3 CILINDROS 12V
- 302292:** AUTOELEVADOR TOYOTA MODELO VIEJO 24V.
- 302294:** AUTOELEVADOR BALKANCAR RECORD PERKINS 4236 12V.
- 302296:** FIAT R60 REEMPLAZO BPD Z9 24V.
- 302297:** MOTONIVELADORA CHINA XCMG-GR-215 24V. Z9
- 302298:** CATERPILLAR 320L SERIE 9KK02415 24V.
- 302299:** MAQUINA RETROEXCAVADORA VOLVO 220 24V. Z9
- 302300:** MAQUINA ROMPEDORA DE ASFALTO DEUTZ Z9 Ø34,5 12V.
- 302301:** TRACTOR CASE C/ MOTOR PERKINS 6 CIL. Z10 12V.
- 302306:** MOTONIVELADORA ORION RUSA 24V.
- 302308:** MAQUINA VIAL CHINA 24V. Z11 Ø40,8
- 302310:** AUTOELEVADOR CHINO XCMG LW166 4 CIL. 24V. Z9
- 302312:** JEEP WILLYS AMERICANO Z10 Ø37 12V.
- 302313:** PALA CARGADORA FRONTAL MICHIGAN 45 12V. Z11 Ø39.5
- 302315:** PALA CARGADORA LIUGONG 6 CIL. 24V. Z11 Ø53
- 302316:** PALA RETROEXCAVADORA UCRANIANA BOREX UMZ 12V. Z10 Ø36
- 302318:** SAMPI MOTOR PERKINS INGLES 6 CIL. 12V. Z11 Ø40.8
- 302319:** MOTOR ESTACIONARIO HATZ ALEMAN 2/3/4 CIL. 12V. Z11 Ø40.8
- 302320:** PICK UP NISSAN DIESEL MOTOR 2.3 MOD. 92 12V. Z9 Ø35,5
- 302322:** TOPADORA CATERPILLAR D747A 12V. Z9 Ø29,5 GIRO IZQ.
- 302325:** ESTACIONARIO HANOMAG CHINO 3 CIL. 100/157/204 HP 24V. Z11 Ø40,8
- 302329:** AUTOELEVADOR YALE MOTOR VALIANT NAFTERO 12V. Z9 Ø29
- 302330:** CLARK MITSUBISHI 12V. Z10 Ø40
- 302334:** CAMION LEYLAND COMET 24V. Z12 Ø46, 6 CIL. 150 HP 1969
- 302335:** CAMION UNIMOG 2 OREJAS 12V. Z11 Ø39.5
- 302338:** TRACTOR VALTRA 12V. Z11 Ø40.5
- 302339:** PALA CARGADORA LIUGONG CLC 816 24V. Z9 Ø33
- 302340:** AUTOELEVADOR TOYOTA MODELO VIEJO 12V. Z9 Ø52,5
- 302343:** TRATOR JOHN DEERE 2300 12V. Z11 Ø40.8
- 302344:** CATERPILLAR 3406B DITA 6 CIL. 24V. Z11 Ø56 GENERADOR 365 KVA
- 302345:** GRUPO ELECTROGENO SAME MOTOR DEUTZ 3 CIL. 12V. Z11 Ø40,8
- 302346:** TRACTOR PORSCHE 12V. Z9 Ø34.5
- 301083/11/24:** PALA MICHIGAN 24V. Z11 Ø40,8MM.
- 302274:** TRACTOR FIAT 450 12V. Z9 Ø35.5MM.
- 302285:** NEW HOLLAND AGRICULTOR 1500RPM MOTOR DIESEL R4105ZD FUERZA 56KW.
- 302291:** PALA CHINA (YLIHAK YYC6798767)
- 302302:** PALA CARGADORA PAYLOADER 16 24V. Z9
- 302313/24:** PALA CARGADORA FRONTAL MICHIGAN 45 24V. Z11 Ø39.5MM.
- 302342:** PALA FRONTAL XCMG LW321F 24V. Z11 Ø53MM.
- 302347:** GRUPO ELECTROGENO 24V.

ARRANQUE BNG / BPD / FKB

 <p>100010 FKB - VOLVO - M.DEUTZ S.VABIS - SIN OREJAS</p>	 <p>100010A FKB - M.BENZ - DEUTZ-T.BOSCH SOPORTE 3 TORNILLOS</p>	 <p>100015G CUBREIMPULSOR ARRANQUE TIPO BOSCH</p>	 <p>100017 ARRANQUE BPD</p>
 <p>100019 SCANIA ARR. FKB - T.BOSCH</p>	 <p>100022 FKB - FIAT 619 - M.DEUTZ</p>	 <p>100023 M.BENZ - SCANIA (SUECO) ARR. T.BOSCH - FKB 218</p>	 <p>101016 BNG - M.BENZ 312 - FIAT DEUTZ - CON BUJE</p>
 <p>101017 BNG CÓNICA - SIN OREJA CON BUJE</p>	 <p>101060 REEMPL. ARR. DELCO-REMY M.BENZ-MAQ. VIALES-Ref. DIPRA</p>	 <p>101388 DELCO-REMY - M.BENZ CUMMINS (99 1651)</p>	 <p>101430 REF. REEMPLAZO BNG-CAV</p>
 <p>101469 REEMPL. BNG-CAV IMPULSOR Z9 - Ref. DIPRA</p>	 <p>101469/10 REEMPL. BNG-CAV IMPULSOR Z10 - Ref. DIPRA</p>		
<h2>ARRANQUE CUMMINS</h2>			
 <p>101168 FORD CARGO MOTOR CUMMINS-INDIEL M93R</p>	 <p>101171 FORD CARGO 1622 T.INDIEL M100R. CUMMINS 6CTAA 8.3</p>	 <p>101172 T.INDIEL M93R CUMMINS 6BT</p>	 <p>101384 M.BENZ 712/1113(ELECT.) MOT. CUMMINS - TIPO BOSCH</p>
 <p>101388 T. DELCO-REMY 28MT M.BENZ 1720 CUMMINS(99 1651)</p>	 <p>101389 T. DELCO-REMY UNIPOINT</p>	 <p>101399 T. DELCO-REMY - CUMMINS M.BENZ</p>	

ARRANQUE PERKINS

 <p>100097/98 BEDFORD - PERKINS ARRANQUE CAV</p>	 <p>100099 PERKINS 6-354 / J.DEERE (M.VIEJO) T. INDIEL</p>	 <p>101240 PERKINS 6-354 / FORD 7000 T. INDIEL AN115 (35256240)</p>	 <p>101305 PERKINS 6-305/4-203 - AN115 T. INDIEL (35256305)</p>
--	--	--	---

 <p>101405 PERKINS 6-305/4-203 T. NASHVILLE</p>	 <p>101591 PERKINS 6-305/4-203 / J.DEERE FORD 600D-T.INDIEL-MOD. VIEJO</p>		
---	--	--	--



ARRANQUES VARIOS

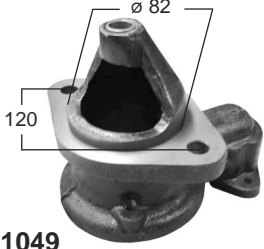
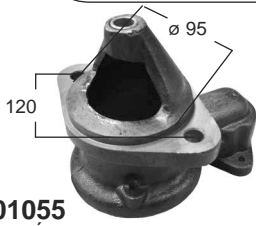

 <p>100107 BORGWARD TURBO - BOSCH</p>	 <p>101075 ARR. MOTOR KUBOTA-Ref. DIPRA</p>	 <p>101082 CAMIÓN CON CESTA ELEVADORA</p>	 <p>101185 CATERPILLAR, JOHN DEERE, FORD T. INDIEL M100R (35259378)</p>
--	--	---	--

CAMIONES ASIÁTICOS

 <p>101049 3STAR - JAC - LYDON - JINBEI YUEJIN - Ref. DIPRA</p>	 <p>101055 CAMIÓN SANXING - BLACK ASIÁTICO Ref. DIPRA</p>		
---	---	--	--

CHEVROLET

 <p>100038 CHEVROLET 400 - PICK-UP OPEL K180 - T.INDIEL (4A504479)</p>	 <p>100038/1 CHEVROLET 400 - PICK-UP OPEL K180 - T.GAREF</p>	 <p>100097/98 BEDFORD - PERKINS ARRANQUE CAV</p>	 <p>101040 BEDFORD TODOS - CHEVROLET Ref. AN115 (35256322)</p>
--	--	---	--

 <p>101177 CHEVROLET CORSA 1.6 TIPO BOSCH</p>	 <p>101211 CHEVROLET D20 CON MOTOR MWM (35258692)</p>		
---	---	--	--

DEUTZ



101426
DEUTZ 913 - AN 115 - T. INDIEL
(35257050)



101427
DEUTZ 70 / 85 - FHAR - Ref. AN 115



101428
DEUTZ 913 - ARR. T. NASHVILLE



101429
DEUTZ 913 - TIPO BOSCH



101430
REF. REEMPLAZO BNG-CAV



101469
REFORMA DIPRA-REEMPLAZO
ARR. BNG. CAV-IMPULSOR Z9



101469/10
REFORMA DIPRA-REEMPLAZO
ARR. BNG. CAV-IMP. Z10 - Z11

FIAT



100022
CAMIÓN FIAT 619-M.DEUTZ FKB
T. BOSCH



100123
FIAT 600/750
(SOLENOIDE 2 AGUJ.) T.GAREF



100125
FIAT 1100 - (SOLENOIDE
2 AGUJ.) T.GAREF



100127
FIAT 1100 - (SOLENOIDE 3 AGUJ.)
T.GAREF



100129
FIAT 1500 - T. GAREF
(3020038)



100322
FIAT 673 MOT.CP3-FIAT 900-1100
BEDFORD - M75 - T.INDIEL



101000
FIAT 600/750 (SOLENOIDE
3AGUJ.) TIPO GAREF (5106000)



101047
CAMIÓN FIAT 619 - Ref. DIPRA
REEMPLAZO ARR. FKB



101048
FIAT TRACTOR 550/640/980
Ref. DIPRA



101048/1
FIAT TRACTOR 540/550
Ref. DIPRA - DIESEL LIGERO



101056
FIAT 619 N1 - Ref. DIPRA
REEMPLAZO ARR. MARELLI



101166
FIAT DUNA 1.4/1.6
T.INDIEL (35257892)



101190
FIAT FIORINO MOTOR FIRE
T. BOSCH



101307
TRACTOR FIAT 900E - T. INDIEL



101325
FIAT 128 - T.GAREF (5105325)



101326
FIAT 128 S.EUROPA - DUNA-UNO
T. GAREF (5105850)

FIAT

 <p>101327 FIAT 133 - T. GAREF</p>	 <p>101328 FIAT 147/DUNA/FIORINO T. MAGNETI MARELLI</p>	 <p>101329 FIAT 147/DUNA/UNO/FIORINO MOTOR TIPO - T.GAREF(5105875)</p>	 <p>101330 FIAT DUNA/UNO 1.5 MOTOR TIPO - T. BOSCH</p>
 <p>101331 FIAT 147/UNO/DUNA - T.BOSCH MOTOR TIPO</p>	 <p>101333 FIAT PALIO - SIENA - T.BOSCH (100582812)</p>	 <p>101334 FIAT DUCATO MOTOR 1.9/2.5 MAGNETI MARELLI</p>	 <p>101335 FIAT DUNA - UNO - DIESEL MOTOR 1.7 - T.BOSCH</p>
 <p>101337 FIAT DUNA-UNO-DIESEL MOTOR 1.7 TURBO T.INDIEL M74R (35258485)</p>	 <p>101337/1 FIAT TURBO DIESEL 1.7 T. INDIEL</p>	 <p>101337/2 FIAT PALIO DIESEL T. INDIEL</p>	 <p>101338 FIAT PALIO - SIENA MARELLI (1005821812)</p>
 <p>101339 FIAT DUCATO MOTOR 2.5/2.8 MAGNETI MARELLI</p>	 <p>101469/10 TRACTOR FIAT 400/500/650/700 ETC. Ref. DIPRA REEMPLAZO BNG-CAV</p>	 <p>101470 FIAT 450 SOMECA - Ref. DIPRA</p>	 <p>101472 FIAT TRACTOR 411 - Ref. DIPRA</p>
 <p>101473 FIAT TRACTOR 400/500/500S/U25</p>	 <p>101474 FIAT 150 TURBO T.INDIEL</p>	 <p>101474/1 FIAT DAILY EUROCARGO TIPO INDIEL</p>	 <p>101475 FIAT 150 TURBO - T. NASHVILLE</p>
 <p>101475/1 FIAT DAILY EUROCARGO TIPO NASHVILLE</p>	 <p>101476 FIAT 150 TURBO - TIPO BOSCH</p>	 <p>101476I FIAT IVECO DAILY EUROCARGO TIPO BOSCH</p>	 <p>101780 TRACTOR FIAT 780 - 60R Ref. AN115</p>

FIAT



101781
TRACTOR FIAT 780 - Ref. DIPRA
ARR. 301781 REEMPL. ARR BNG



101782
TRACTOR FIAT 780 - Ref. DIPRA
ARR. 301782 REEMPL. MARELLI

FORD



100003
FORD F-100/350 MOTOR V8
(4A501032)



100099
PERKINS 6-354
JOHN DEERE (M.VIEJO)



101164
FORD FALCON/FAIRLANE 62/67
TIPO INDIEL (4A504164)



101165
FORD TAUNUS - T.INDIEL
(32256733)



101167
FORD CAMIÓN C/MOTOR MWM
Ref. DIPRA (35258294)



101168
FORD CARGO MOT. CUMMINS
INDIEL M93R



101171
FORD CARGO 1622 MOT.CUMMINS
6CTAA 8.3 T.INDIEL M100R



101172
MOTOR CUMMINS 6BT
T.INDIEL M93R (35258913)



101176
FORD KA MOTORCRAFT



101179
FORD KA TIPO VALEO



101180
FORD FALCON FRONTAL T. INDIEL



101185
CATERPILLAR, JOHN DEERE,
FORD T. INDIEL M0100R
(35259378)



101209
ARR. M93R, FORD F100-250-4000-
7000-14000 C/ MOTOR MWM
(35260972)



101210
FORD RANGER 3 LTS
(35258742)



101305
PERKINS 6-305/4-203 - AN115
T.INDIEL (35256305)



101405
PERKINS 6-305/4-203
TIPO NASHVILLE



101591
PERKINS 6-305/4-203 - J.DEERE
FORD 600D-T.INDIEL-MOD.VIEJO

GROSSPAL



101061
CAMIÓN GROSSPAL
MOTOR NISSAN-Ref. DIPRA

IKA



101027
JEEP IKA/ESTANCIERA/KAISER



101027/1
MOTOR CONTINENTAL
AUTOELEVADOR Ref. DIPRA



101027/2
MOT. CONTINENTAL - JEEP IKA
ESTANCIERA / AUTOELEVADOR
Ref .DIPRA - ALUMINIO



101027/2F
MOT. CONTINENTAL - JEEP IKA
ESTANCIERA / AUTOELEVADOR
Ref .DIPRA - FUNDICIÓN GRIS



101562
RAMBLER - TORINO 300L/300S



101200
CUBREIMPULSOR ARRANQUE

JOHN DEERE



100099
PERKINS 6-354
JOHN DEERE MOD. VIEJO



101063
JOHN DEERE 1800 - Ref. DIPRA



101064
JOHN DEERE 445 - Ref. DIPRA



101068
JOHN DEERE 1420/2030/2530
HASTA 1975 (35256524)



101185
JCATERPILLAR, JOHN DEERE,
FORD T. INDIEL M0100R
(35259378)



101307
M.BENZ 608 - JOHN DEERE - FIAT
DEUTZ - T.INDIEL (35256446)

MERCEDES BENZ



100020
M.BENZ 170 - TIPO BOSCH



100023
M.BENZ - T.BOSCH - FKB 218



101016
BNG - M.BENZ 312



101017
BNG CÓNICA (SIN OREJA)



MERCEDES BENZ

 <p>101060 M.BENZ SUPERTORQUE 1633/1638/1648 - Ref. DIPRA</p>	 <p>101307 M.BENZ 608 - JOHN DEERE - FIAT DEUTZ - T.INDIEL (35256446)</p>	 <p>101383 M.BENZ - T. BOSCH J.F.</p>	 <p>101384 M.BENZ 712/1113 (ELECTRÓNICO) MOT. CUMMINS - TIPO BOSCH</p>
 <p>101385 M.BENZ 608 - TIPO BOSCH J.F.</p>	 <p>101388 DELCO REMY - MOT. CUMMINS (99 1651)</p>	 <p>101389 DELCO-REMY UNIPOINT</p>	 <p>101399 DELCO-REMY CUMMINS - M-BENZ</p>
 <p>101420 M.BENZ - TIPO NASHVILLE</p>	 <p>101469 REEMPL. BNG-CAV IMPULSOR Z9 Ref.DIPRA</p>	 <p>101649 M.BENZ 1517/608 DESDE 1978 TIPO INDIELAN115</p>	 <p>101649/1 M.BENZ 911/1112/1114 HASTA 1979 TIPO INDIEL - SOLENOIDE RECTO</p>

MITSUBISHI

 <p>101050 MITSUBISHI CANTER - Ref. DIPRA</p>		
---	--	--

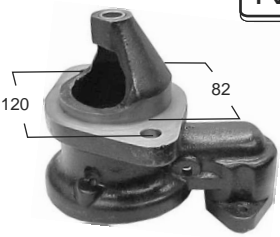
NISSAN

 <p>101052 NISSAN 4 Y 6 CIL. - Ref. DIPRA</p>	 <p>101053 NISSAN 4 CIL. Ref. DIPRA</p>	 <p>101714 NISSAN V16 - SENTRA - NAFTA ARR. BOSCH MEXICANO</p>
---	---	---

PEUGEOT

 <p>100154 PEUGEOT 403</p>	 <p>100154/1 PEUGEOT 404 - TIPO TAMATEL</p>	 <p>100154/2 PEUGEOT 404-T.INDIEL (4A5/2127)</p>	 <p>100154/3 PEUGEOT 504 - TAMATEL</p>
--	---	---	--

PEUGEOT

 <p>100154/4 PEUGEOT 404 - T.FENSACO</p>	 <p>100154/5 PEUGEOT 504 - T.FENSACO</p>	 <p>100160 PEUGEOT 404/504 - T.INDIEL (SOLENOIDE 2AGUJ.) 4A501752 CON BUJE 314</p>	 <p>100160/1 PEUGEOT 404/504 - T.DUCELLIER CON BUJE 902</p>
 <p>100160/2 PEUGEOT 504/505 2000CC T.INDIEL (SOLENOIDE 4 AGUJ.)</p>	 <p>100160/3 PEUGEOT DIESEL LIGERO BUJE GRANDE - EJE 15MM T.INDIEL (35257706)</p>	 <p>100160/4 PEUGEOT DIESEL LIGERO BUJE CHICO - EJE 14MM T.INDIEL (35256550)</p>	 <p>100160/5 PEUGEOT 504/505 T.INDIEL M93 (35257888)</p>
 <p>100250/3 PEUGEOT - RASTROJERO MOTOR INDENOR T.INDIEL (36256068)</p>	 <p>101100 PEUGEOT 404/504 - T.GAREF</p>	 <p>101102 PEUGEOT 405 - T.BOSCH</p>	 <p>101173 PEUGEOT 405/306 VALEO</p>
 <p>101182 PEUGEOT 206/306 ARR. T.VALEO</p>	 <p>101800 PEUGEOT 504/505 2000 - T.GAREF</p>		
<h2>RASTROJERO</h2>			
 <p>100102 BORGWARD - T.BOSCH</p>	 <p>100106 BORGWARD - T.INDIEL</p>	 <p>100106/1 BORGWARD-T.INDIEL Ref. DIPRA</p>	 <p>100106/1D BORGWARD - DIESEL LIGERO Ref. DIPRA</p>
 <p>100106/2 INDENOR - Ref. DIPRA</p>	 <p>100250 INDENOR - F I 547040 ENTRECENTROS ORIFICIOS AUTOMÁTICO 57MM</p>	 <p>100250/1 IME - ENTRECENTROS ORIFICIOS AUTOMÁTICO 54,5MM</p>	 <p>100250/2 IME MODELO NUEVO</p>

RASTROJERO



100250/3
PEUGEOT - RASTROJERO
MOTOR INDENOR
T.INDIEL (36256068)

RENAULT



100150
RENAULT 4 - DAUPHINE
GORDINI - T.DUCELLIER



100158
RENAULT 4/6/12/18/19 - T.INDIEL
(35255545)



101157
RENAULT 18-19-KANGOO-TRAFIC
T.INDIEL

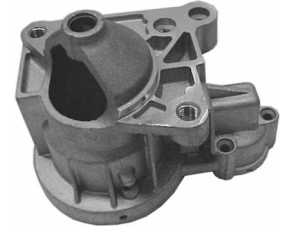

101158
RENAULT 9-19 - T.BOSCH
(9001.082.698)



101159
RENAULT TRAFIC - R18 DIESEL
T.INDIEL (35257918)



101160
RENAULT 12-18- T.ARGELITE



101161
RENAULT 12-18- T.INDIEL M93
(35257830)



101162
RENAULT 18 1400CC - TRAFIC
T.INDIEL (35257760)



101163
RENAULT 11/12/18 MOT. 1600CC
T.INDIEL (35257550) - TORN. LARGO



101163/1
RENAULT 11/12/18 MOT. 1600CC
T.INDIEL (35258529) - TORN. CORTO



101169
RENAULT 19 - T.VALEO



101170
RENAULT 19 - KANGOO - TRAFIC
T.VALEO



101175
RENAULT 9/11/19 MOTOR 1.6
T.ARGELITE



101178
RENAULT 18 2000CC NAFTA
MOD. VIEJO - T.INDIEL (35257483)



101181
RENAULT LOGAN - KANGOO
T.VALEO



101183
RENAULT LOGAN - KANGOO
T.BOSCH



101184
RENAULT 18 NAFTERO
MOTOR 2000 T.INDIEL M93

SCANIA



100019
SCANIA T.BOSCH - FKB



101054
SCANIA - Ref. DIPRA



101386
SCANIA 220/250/260
T.BOSCH (2005834027)

SIAM



100081
TAPA DE ARRANQUE SIAM

TATA



101066
CAMIÓN TATA - Ref. DIPRA

TOYOTA



101058
TOYOTA - Ref. DIPRA
REEMPLAZO NIPPONDENSO

AGUJERO CON ROSCA

TRACTORES



101043
TRACTOR HANOMAG 55 (LADO
DERECHO ENCASTRE Ø57MM)



101044
TRACTOR HANOMAG 33/35
Ref. DIPRA 62MM



101045
MOTOR BELARUZ Ref. DIPRA



101046
MOTOR RUSLAN - Ref. DIPRA



101048
TRACTOR UNIVERSAL - GROSSI
FIAT 540-640-980 - ETC.



101048/1
TRACTOR UNIVERSAL - GROSSI
FIAT-ETC.-Ref. DIPRA (D.LIGERO)



101469
REEMPL. BNG-CAV
IMPULSOR Z9 - Ref. DIPRA

VW/DODGE



101174
VW POLO - T.BOSCH



101186
VW POLO CON REDUCCION
T.BOSCH



101187
VW FOX - SURAN
T. VALEO (438179)

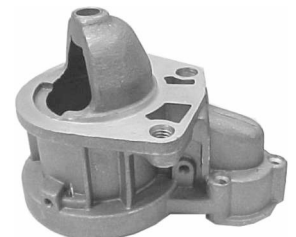

101332
GOL-SENDA-FORD 1.6-T.BOSCH



101704
DODGE - DE SOTO (1752392)
3 AGUJEROS



101704/1
DODGE D100/400 - 1957/8
SOPORTE 2 AGUJEROS



101704/2
DODGE D100 - DE SOTO
Ref. DIPRA - EJE 12MM

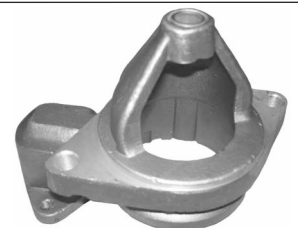











101710
VW1500 - DODGE 1500 - T.TRIA
DESDE 1980













VW/DODGE

 <p>101711 VW1500 - DODGE 1500 T.GAREF (5100255)</p>	 <p>101712 VW GOL - SENDA - SAVEIRO ESCORT - T.BOSCH</p>	 <p>101715 VW GOL - SENDA - SAVEIRO T.WAPSA - FUNDICIÓN GRIS</p>	 <p>101189 CUBREIMPULSOR ARRANQUE</p>
--	--	---	---

TAPAS INTERMEDIAS

 <p>501045 CHEVROLET (35256345)</p>	 <p>501059 RAMBLER, KAISER, ESTANCIERA, DODGE</p>	 <p>501105 RASTROJERO BORGWARD - T.INDIEL</p>	 <p>501115 RASTROJERO MOTOR IME</p>
 <p>501116 TIPO BOSCH J.F. BRASIL, M. BENZ, DEUTZ</p>	 <p>501118 ARRANQUE TIPO BOSCH/DELCO REMY MOTOR M. BENZ SUPERTORQUE</p>	 <p>501120 ARRANQUE TIPO DELCO REMY 28MT</p>	 <p>501703 ARRANQUE TIPO INDIEL AN115 M. BENZ, PERKINS, ETC.</p>
 <p>501704 RENAULT TRAFIC TIPO INDIEL</p>	 <p>501705 RENAULT TS-R12/18</p>	 <p>501706 ARRANQUE AN115 CON RETEN</p>	

SUPLEMENTOS DE ARRANQUE

 <p>902108 COLLAR BEDFORD, PERKINS</p>	 <p>902109 COLLAR M. BENZ</p>	 <p>902109/1 COLLAR M. BENZ GRUESO</p>	 <p>902120 COLLAR FORD FALCON</p>
 <p>902121 COLLAR MOTOR MWM, FORD</p>	 <p>902122 COLLAR CHAPA CUBRE An115</p>	 <p>902123 ARRANQUE AN 115 ESPESOR 7MM.</p>	 <p>902124 COLLAR ARRANQUE BORGWARD 8MM.</p>
 <p>902125 COLLAR ARRANQUE IKA 5MM.</p>	 <p>902126 ARRANQUE REFORMA DIPRA FIAT 700 18MM</p>	 <p>902127 ARRANQUE FIAT DUCATO (NÚMERO ORIGINAL 5978701-A505)</p>	 <p>902128 COLLAR ARRANQUE FIAT 411 13MM.</p>
 <p>902130 COLLAR PARA CUBRE 100023</p>			

SUNCHO Y MASA POLAR



901110/2
MASA POLAR AN 115 LARGA
901111/2
MASA POLAR AN 115 CORTA

901110B/2
MASA POLAR ARRANQUE
TIPO BOSCH



902039
1 SUNCHO DE CHAPA ARRANQUE AN 115 COMPLETO

CARCAZAS



901110
CARCAZA LARGA C/MASAPOLAR
Y TORNILLOS

901110/4
CARCAZA AN 115 COMPLETA

901111
CARCAZA CORTA C/MASA
POLAR Y TORNILLOS

901111/4
CCARCAZA AN 115 CORTA
COMPLETA



901110B
CARCAZA BOSCH C/MASA POLAR Y TORNILLOS

901110B/4
CARCAZA BOSCH CON DESPIECE



901114
CARCAZA ARRANQUE TIPO INDIEL M93



901115
CARCAZA TIPO VALEO D6R
GIRO HORARIO (CW)

901116
VCARCAZA TIPO VALEO D6R
GIRO ANTIHORARIO (CCW)

CAMPOS DE ARRANQUE



253119
TIPO INDIEL AN115 25V. LARGO (ESPECIAL) FIAT 780, DEUTZ,
M. BENZ, FIAT CHICO, PERKINS, ETC.

TAPAS PORTAESCOBILLAS

<p>801015 ARRANQUE ESTANCIERA, IKA, RAMBLER</p>	<p>801021 DE ARRANQUE FIAT 1500</p>	<p>801040 ARRANQUE TIPO INDIEL M93 SIERRA, RENAULT</p>	<p>801040C ARRANQUE TIPO INDIEL M93 SIERRA, RENAULT C/CARBONES</p>
<p>801096/1 ARRANQUE TIPO INDIEL AN115</p>	<p>801096/1A AN115 TODA AISLADA</p>	<p>801096/1C ARRANQUE AN 115 CON CARBONES</p>	<p>801096/2 ARRANQUE TIPO NASHVILLE PERKINS, M. BENZ, DEUTZ, ETC.</p>
<p>801100 ARRANQUE TIPO BOSCH, FKB</p>	<p>801100A FKB AISLADO</p>	<p>801100B ARRANQUE TIPO BOSCH, FKB ARMADA</p>	<p>801100C ARRANQUE TIPO BOSCH, FKB ARMADA</p>
<p>801104 ARRANQUE FORD, CHEVROLET, TIPO INDIEL</p>	<p>801128 ARRANQUE FIAT 600/750/1100 TODOS</p>	<p>801151 ARRANQUE TIPO GAREF FIAT, D1500, PEUGEOT</p>	<p>801151C ARRANQUE TIPO GAREF FIAT, D1500, PEUEUGEOT C/CARBONES</p>
<p>801151/3C FIAT, D1500 C/CARBONES TIPO GAREF</p>	<p>801151/4 RENAULT, PEUGEOT TIPO INDIEL C/4 PORTA CARBONES</p>	<p>801151/4C ARRANQUE RENAULT, FIAT C/4 PORTA CARBONES Y CARBONES</p>	<p>801151/5 ARRANQUE RENAULT, FIAT, PEUGEOT</p>
<p>801151/5C ARRANQUE RENAULT, FIAT, PEUGEOT C/CARBONES</p>	<p>801151/6 ARRANQUE CITROEN 2CV 6V. DESDE 68</p>	<p>801151/6C ARRANQUE 2CV 6V. DESDE 68 C/CARBONES</p>	<p>801151/7 ARRANQUE PEUGEOT, FIAT TIPO GAREF</p>

TAPAS PORTAESCOBILLAS

 <p>801151/7C ARRANQUE PEUGEOT, FIAT TIPO GAREF C/CARBONES</p>	 <p>801151/8 PEUGEOT, FIAT TIPO GAREF C/4 CARBONES</p>	 <p>801151/8C PEUGEOT, FIAT TIPO GAREF C/4 CARBONES</p>	 <p>801153 ARRANQUE TIPO DUCCELL-TAMATEL PEUGEOT</p>
 <p>801153C AARRANQUE TIPO DUCCELL-TAMATEL PEUGEOT C/CARBONES</p>	 <p>801360 ARRANQUE RASTROJERO MOTOR INDENOR</p>	 <p>801360/1 ARRANQUER ASTROJERO MOTOR INDENOR</p>	 <p>801361 MOTOR HIDRAULICOS P/RULEMAN</p>
<p>801287 ARRANQUE TIPO INDIEL M100 FORD, G.MOTORS, FIAT (PLASTICO)</p> <p>801287B FORD, G.M., FIAT (BAQUELITA)</p>		<p>801287C ARRANQUE TIPO INDIEL M100 C/CARBONES</p> <p>801287BF INDIEL M100 FALCON C/CARBONES</p>	
 <p>801365 ARRANQUE RASTIPI M. BENZ 170 BORGWA</p>	 <p>801372 TIPO WAPSA GOL, SENDA DIESEL</p>	 <p>802029 TIPO BOSCH ALEMAN M. BENZ</p>	 <p>802042 ARRANQUE BNG M. BENZ 12 Y 24V. 1 SALIDA</p>
 <p>802042/1 ARRANQUE BNG M.BENZ 12 Y 24V. 2 SALIDAS</p>	 <p>802070 DE CHAPA ARRANQUE INDIEL RENAULT, PEUGEOT, FIAT, ETC.</p>	 <p>802071 ARRANQUE TIPO BOSCH FIAT, FORD, VW (2.005 .852 .008)</p>	 <p>802072 GUARDA POLVO ARRANQUE FKB (2.000. 580.121)</p>
 <p>802369 ARRANQUE GAREF CHEVROLET</p>	 <p>802370 ARRANQUE TIPO BOSCH BRASIL M. BENZ, ETC.</p>	 <p>802371 ARRANQUE BOSCH M.BENZ S/TORQUE ETC.</p>	 <p>802375 ARRANQUE TIPO WAPSA</p>

























TAPAS PORTAESCOBILLAS

 <p>802472 ARRANQUE TIPO INDIEL M74RD (4525842)</p>	 <p>802473 ARRANQUE HITACHI M74R GIRO IZQ. POLO DIESEL, POINTER, ORION (COD. NUEVO 35261126 - COD. VIEJO 35258304)</p>	 <p>802474 ARRANQUE DELCO REMY 28MT</p>	 <p>802475 ARRANQUE TIPO INDIEL M93R CHEVROLET, FORD, GM, MWM</p>
 <p>802476 ARRANQUE TIPO VALEO VW FOX/SURAN (CÓDIGO 438179)</p>	 <p>802477 ARRANQUE FIORINO MOTOR FIRE TIPO BOSCH</p>	 <p>802477/1 ARRANQUE RENAULT LOGAN/ SANDERO TIPO BOSCH</p>	 <p>802478 ARRANQUE TIPO VALEO PEUGEOT</p>
 <p>802703 ARRANQUE INDIEL M74DD (35258703)</p>			

COLLARES Y SEGUROS

 <p>C1013 ARRANQUE TIPO INDIEL AN 115 TODOS EJE 15MM.</p>	 <p>C1062 ARRANQUE TIPO INDIEL, CHEVROLET, FALCON, RENAULT, ETC.</p>	 <p>C1063 ARRANQUE TIPO GAREF FIAT 1500/1600 EJE 14MM.</p>	 <p>C1064 ARRANQUE TIPO GAREF FIAT 128/PEUGEOT</p>
 <p>C1065 ARRANQUE TIPO BOSCH RASTROJERO EJE 14MM.</p>	 <p>C1066 ARRANQUE FRONTAL TIPO INDIEL M74</p>	 <p>C1067 ARRANQUE ESCORT TIPO INDIEL</p>	 <p>C1068 ARRANQUE TIPO BOSCH VW BRASILEIRO EJE 11MM.</p>
 <p>C1069 ARRANQUE TIPO GAREF FIAT 147, UNO, DUNA EJE 11.5MM.</p>	 <p>C1072 ARRANQUE TIPO DELCO REMY 28MT EJE 14MM.</p>	 <p>C1073 ARRANQUE TIPO VALEO EJE 11.50MM. SEGURO DE 1.5MM.</p>	 <p>C1074 ARRANQUE TIPO VALEO EJE 11.50MM. SEGURO DE 2MM.</p>

COLLARES Y SEGUROS

 <p>C1075 ARRANQUE TIPO PARIS RHONE EJE 13MM.</p>	 <p>C1076 ARRANQUE TIPO BOSCH EJE 14.2MM.</p>	 <p>C1077 ARRANQUE TIPO NASHVILLE EJE DE 15MM.</p>	 <p>C1078 ARRANQUE TIPO INDIEL AN 115 REFORZADO Z10</p>
 <p>C1079 ARRANQUE TIPO INDIEL AN 115 REFORZADO Z9</p>	 <p>C1081 ARRANQUE FIAT FIRE EJE 10MM.</p>	 <p>C1082 ARRANQUE TIPO INDIEL TRAFIC/ PEUGEOT DIESEL EJE 14MM.</p>	 <p>C1083 ARRANQUE TIPO VALEO, EJE 8MM.</p>
 <p>C1084 ARRANQUE TIPO WAPSA- MOTORCRAFT</p>	 <p>C1085 ARRANQUE TIPO FENSACO RENAULT 12</p>	 <p>C1086 ARRANQUE TIPO INDIEL RENAULT TRAFIC EJE 12MM.</p>	 <p>C1087 ARRANQUE TIPO MITSUBISHI RENAULT 18</p>
 <p>C1088 ARRANQUE TIPO BOSCH- WAPSA CON TAPA EJE 14.20MM.</p>	 <p>C1089 ARRANQUE TIPO LUCAS- MARELLI ETC EJE 17MM.</p>	 <p>C1090 ARRANQUE TIPO BOSCH POLO EJE 7.5MM.</p>	 <p>C1091 ARRANQUE TIPO VALEO RENAULT KANGOO EJE 12MM.</p>
 <p>C1092 ARRANQUE TIPO VALEO MODELO DR7E/DE7E</p>	 <p>C1093 ARRANQUE RENAULT 12 ARRANQUE TIPO INDIEL</p>	 <p>C1094 ARRANQUE TIPO INDIEL AUTOELEVADOR</p>	 <p>C1095 ARRANQUE TIPO INDIEL- PRESTOLITE M100R CORTO, M. BENZ</p>
 <p>C1096 ARRANQUE TIPO INDIEL- PRESTOLITE M100R LARGO, MOTOR CUMMINS</p>	 <p>C1097 ARRANQUE TIPO VALEO EJE 11MM.</p>	 <p>C1098 ARRANQUE TIPO MITSUBISHI EJE 19MM.</p>	 <p>C1099 ARRANQUE TIPO DELCO REMY 29MT EJE 11MM.</p>

TUERCAS Y ARANDELAS

 <p>A1094 SEGURO IMPULSOR ARRANQUE TIPO BOSCH, FKB</p>	 <p>A1095 EJE TENSOR ARRANQUE TIPO BOSCH, FKB</p>	 <p>E1068 ESPINA TUERCA TOPE IMPULSOR INDUCIDO RENAULT</p>	 <p>T9034 JUEGO TUERCAS DE BOBINA ARRANQUE BNG</p>
 <p>T9157 BOBINA ARRANQUE RENAULT, PEUGEOT</p>	 <p>T9158 BOBINA ROSCA IZQUIERDA ARRANQUE FIAT 411</p>	 <p>T9260 BOBINA ROSCA IZQUIERDA ARRANQUE RASTROJERO TIPO BOSCH</p>	

GOMAS AISLACIONES Y RETENES

 <p>G1001 JUEGO DE CIERRE DE CARCAZA (Cant. 1)</p>	 <p>G1001/10 CIERRE CARCAZA AN 115 (Cant. 10)</p>	 <p>G1001/5MB CIERRE DE ARRANQUE AN115 M. BENZ (Cant. 5)</p>	 <p>G1001MB JUEGO DE CIERRE DE ARRANQUE AN115 M. BENZ (Cant. 1)</p>
 <p>G1002 O'RING DE CIERRE TAPA INTERMEDIA (Cant. 2)</p>	 <p>G1003 JUEGO JUNTA ARRANQUE M. BENZ MODELO NUEVO (Cant. 1)</p>	 <p>G1003/5 JUNTA ARRANQUE M. BENZ MODELO NUEVO (Cant. 5)</p>	 <p>G1004 GOMA DE CIERRE ARRANQUE TIPO INDIEL AN115 MODELO NUEVO (Cant. 1)</p>
 <p>G1005 GOMA DE CIERRE ARRANQUE TIPO HITACHI M74R (Cant. 1)</p>	 <p>G1006 GOMA DE CIERRE ARRANQUE TIPO INDIEL / HITACHI M74R (Cant. 1)</p>	 <p>G1007 GOMA DE CIERRE ARRANQUE FORD TAUNUS (Cant. 1)</p>	 <p>G1008 CAPUCHON GOMA SALIDA DE CAMPO AN 115 (Cant. 1)</p>
 <p>G1009 GOMA SALIDA DE CAMPOS ARRANQUE TIPO BOSCH 1 AGUJERO ERO (Cant. 1)</p>	 <p>G1010 GOMA DE CIERRE ARRANQUE FORD TAUNUS (Cant. 1)</p>	 <p>G1012 GOMA AISLANTE SALIDA CAMPOS ARRANQUE TIPO BOSCH / JF 2 AGUJEROS EROS (Cant. 1)</p>	 <p>G1014 JUNTA TAPA DE SOLENOIDE (Cant. 1)</p>

GOMAS AISLACIONES Y RETENES

 <p>G1019 JUNTA DE GOMA GUARDAPOLVO ARRANQUE TIPO BOSCH BNG (Cant. 1)</p>	 <p>G1088 JUNTA CIERRE ARRANQUE FRONTAL TIPO INDIEL (Cant. 1)</p>	 <p>G1170 GOMA DE SALIDA DE CAMPO ARRANQUE TIPO TIPO INDIEL M93R (Cant. 1)</p>	 <p>G1171 GOMA DE SALIDA DE ARRANQUE TIPO TIPO INDIEL M93R (Cant. 1)</p>
 <p>G1172 GOMA DE SALIDA DE CAMPO ARRANQUE TIPO INDIEL / HITACHI M74R (Cant. 1)</p>	 <p>G1184 GOMA DE SALIDA DE CAMPO RENAULT (Cant. 1)</p>	 <p>G1187 GOMA SALIDA DE CAMPO TIPO GAREF (Cant. 1)</p>	 <p>G1188 GOMA SALIDA CAMPO ARRANQUE TIPO NASVILLE / BOCH (Cant. 1)</p>
 <p>G1190 JUEGO DE GOMAS CIERRE ARRANQUE TIPO VALEO (Cant. 1)</p>	 <p>G1191 JUEGO DE GOMA Y BUJE SALIDA DE ARRANQUE TIPO DELCO (Cant. 1)</p>	 <p>G1192 GOMA SALIDA DE CAMPO ARRANQUE TIPO BOCH (Cant. 1)</p>	 <p>G2003 JUEGO RETEN DE PIÑON ARRANQUE BNG (Cant. 1)</p>
 <p>G2004 TAPA RETEN PIÑON ARRANQUE BNG</p>	 <p>G2009 RETEN DE TAPA INTERMEDIA (Cant. 1)</p>	 <p>G2011 JUEGO RETENES DE GOMA DE TORNILLO PASANTE (Cant. 1)</p>	 <p>G3003 JUEGO AISLACIONES CARCAZA AN 115 (Cant. 1)</p>
 <p>G3003/10 AISLANTES DE CARCAZA An115 (Cant. 10)</p>	 <p>G3004 JUEGO AISLACIONES CARCAZA TIPO DELCO REMY 28MT (Cant. 1)</p>	 <p>G3501 JGO. PLANETARIO ARRANQUE TIPO BOSCH CHICO 12X20MM. (Cant. 3)</p>	 <p>G3502 JGO. PLANETARIO ARRANQUE TIPO INDIEL 12X25MM. (Cant. 3)</p>
 <p>G3503 JGO. PLANETARIO ARRANQUE TIPO BOSCH MEDIANO 15X20MM. (Cant. 3)</p>	 <p>G3504 JGO. PLANETARIO TIPO BOSCH GRANDE 15X25MM. (Cant. 1)</p>	 <p>G3505 ANTIVIBRADORA PLANETARIO ARRANQUE TIPO INDIEL M74R (Cant. 1)</p>	 <p>G3506 JGO. PLANETARIO ARRANQUE TIPO INDIEL M100R (Cant. 1)</p>

BOSCH

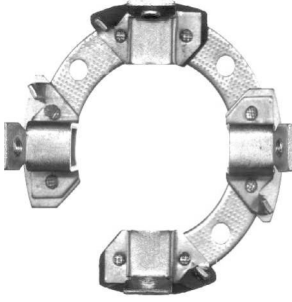

P2041
ARR. BNG ANCHO 12 x 20 x 28.5



P2042
ARR. BNG 24v.

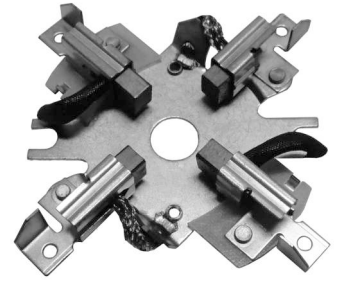

P2125C
ARR. BOSCH 7 x 10 x 18

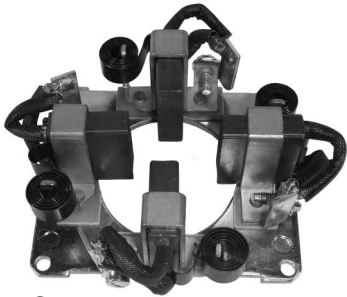

P2126C
ARR. CATERPILLAR
GRUPOS ELECTROGENOS 9.9 x 36 x 27.7



P2127C
ARR. BOSCH 24v.
5 x 10.5 x 12.5

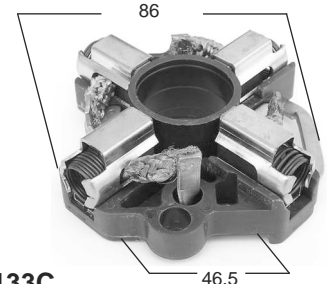

P2133C
ARR. FORD, M.BENZ, NISSAN, OPEL, BMW
7.5 x 18 x 19 (9 003 334 314/1 004 112 906/907)
GIRO HORARIO

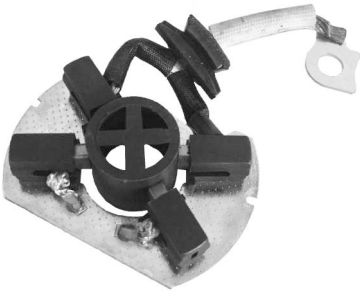

P2140C
ARR. BOSCH, CHEVROLET MONTANA,
FIORINO 1.3 FIRE 4,5 x 8,7 x 10,5 12v.

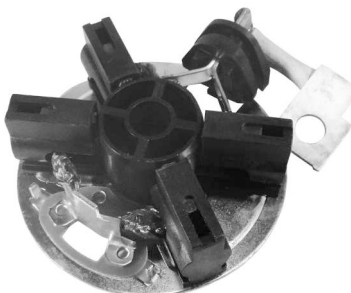

P2142C
ARR. BOSCH, SCANIA (P230, 310, 340, 420)
5,5 x 28 x 18 24v.



P2144C
ARR. BOSCH, SCANIA P, G, R, T (MOTORES
ELECTRONICOS) 6,5 x 28 x 18 24v.



P2145C
ARR. BOSCH, VW VOYAGE
4,6 x 8,4 x 11,5

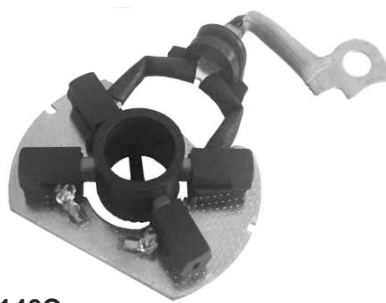

P2146C
PORTAESCOBILLAS ARRANQUE
TIPO BOSCH



P2147C
ARR. BOSCH, FORD CARGO, M. CUMMINS
6.1 x 21 x 17.3 24v.



P2177C
ARR. BOSCH, AUDI A3, VW, FIAT, FORD
4,5 x 10 x 13 12v.

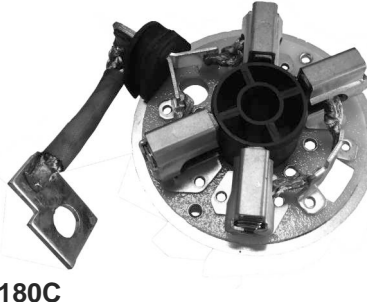

P2180C
ARR. BOSCH, NEW HOLLAND, J.DEERE,
DEUTZ, VOLVO, M.BENZ, FORD,CASE,
IVECO, RENAULT 6,5 x 25 x 16,5 12v.



P2199C
ARR. BOSCH, AUTOELEVADOR,
MAQ. VIALES

BOSCH

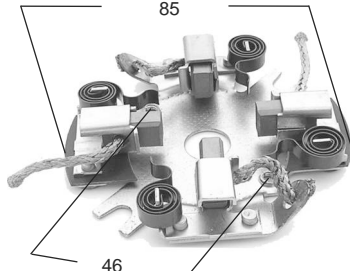

P2201C
ARR. FIAT 147, VW, ESCORT, DUNA, GOL, SENDA, SAVEIRO 6.8 x 9.9 x 16
(9 001 082 518/239)

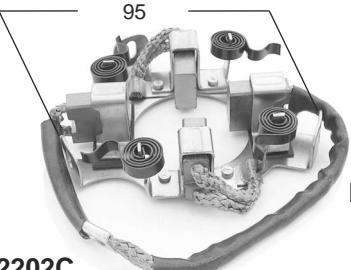

P2202C
ARR. WAPSA, FORD GM, MOTOR MWM, PERKINS. 8.8 x 19.2 x 22
(9 001 453 023) (246007-WAPSA)

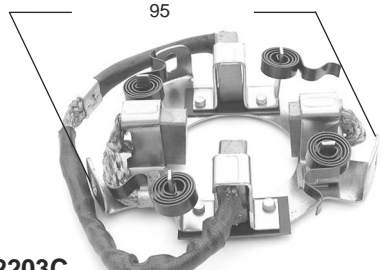

P2203C
ARR. WAPSA, TRACTOR AGRALE DIESEL M790 9 x 19 x 17
(9 001 156 024) (246005 WAPSA)

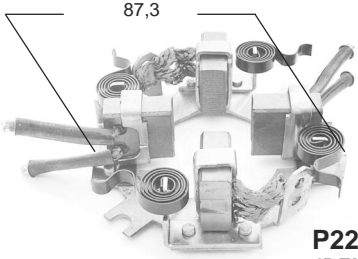

P2204C
ARR. BOSCH JF, M.BENZ 12v.
10 x 22 x 23
(9 001 083 392/362)

P2204/1
IDEM SIN CARBON

P2204C/24
IDEM 24v.

P2205C
ARR. BOSCH M. BENZ DESDE 1983 12v.
10 x 22 x 19
(9 001 083 569)

P2205CR
ARR. BOSCH JF, M.BENZ MODELO NUEVO 24v.
CON CARBON DE 1 CABLE CON TERMINAL ROSCADO. 10 x 22 x 19
(9 001 083 596)

P2205/1
IDEM SIN CARBONES

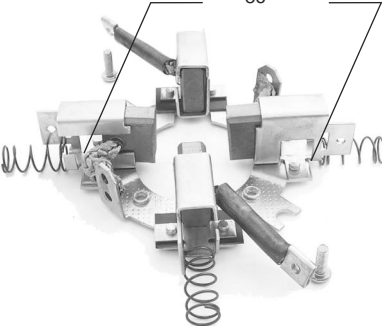

P2205C
ARR. BOSCH M. BENZ DESDE 1983 12v.
10 x 22 x 19
(9 001 083 569)

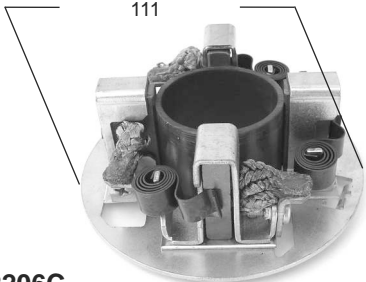

P2206C
ARR. BOSCH JE, M. BENZ, FORD, CUMMINS
8.8 x 35 x 18. 12v.
(9 001 453 640)

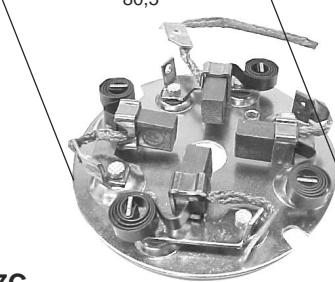

P2207C
ARR. BOSCH WAPSA, GOL, ESCORT, SENDA, SAVEIRO, SANTANA, QUANTUM. 6.8 x 9.8 x 17
(9 001 451 052) (246012 WAPSA)

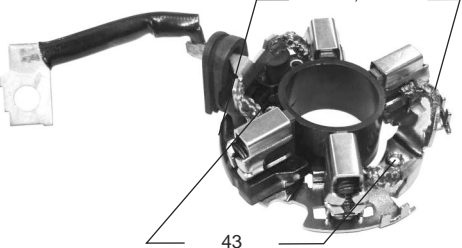

P2209C
ARR. BOSCH FIAT DUNA DIESEL 1.7, VW, POLO. 6 x 18 x 14.5
(1 004 336 807 / 826 / 942 / 959 / 981 / 996)

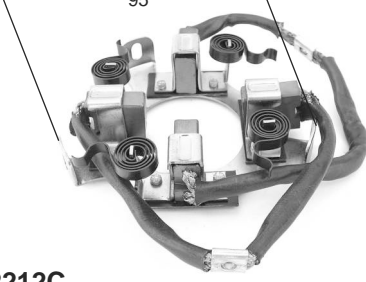

P2212C
ARR. BOSCH WAPSA AUTOELEVADOR CON CASILLEROS AISLADOS. 8.5 x 18.8 x 21.5
(9135081000)

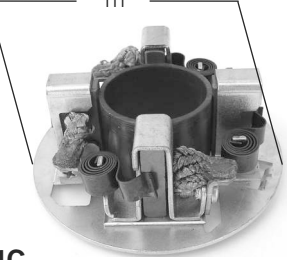

P2214C
ARR. BOSCH JE, M. BENZ SUPER TORQUE, FORD CUMMINS. 8.8 x 35.5 x 18. 24v.
(9 001 453 225)

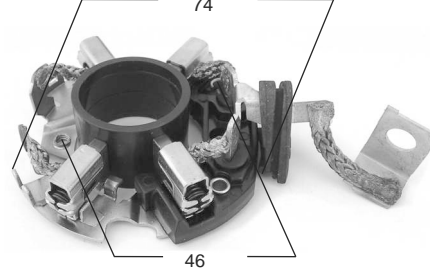

P2215C
ARR. BOSCH PEUGEOT 205, CORSA, ORION, ESCORT, FIESTA, VECTRA. 4.8 x 12 x 11.5
(1 004 336 809) F 000 AL 1 055/283 001 081 094



P2227C
ARR. BOSCH RENAULT TRAFIC EXPRESS
4.8 x 15.8 x 13
(1 004 336 806 / 960 / 968 / 998)

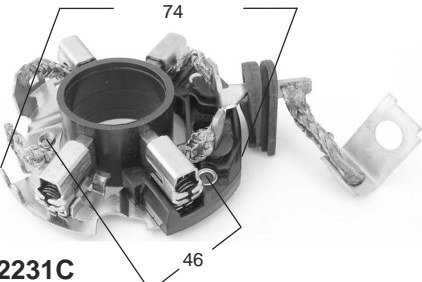

P2231C
ARR. BOSCH
VW GOL 1000 - 5 x 12 x 11.6
(F 000 AL 1 054 / 013 9 001 081 092)



P2233C
ARR. BOSCH PALIO, TEMPRA, VECTRA, ASTRA, OMEGA. 5 x 12 x 11.6
(9 033 334 314 / 1 004 112 906 / 907)

BOSCH

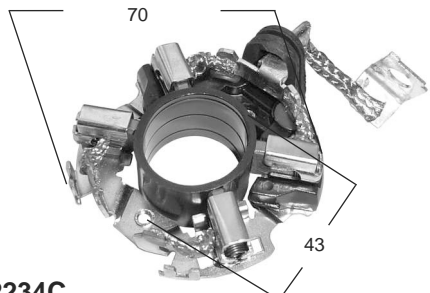

P2234C
ARR. BOSCH ESCORT, POLO, POINTER, GOLF
4.9 x 12 x 11.5
(1 004 336 801 / 821 / 827 / 951 F 000 AL 1 051)

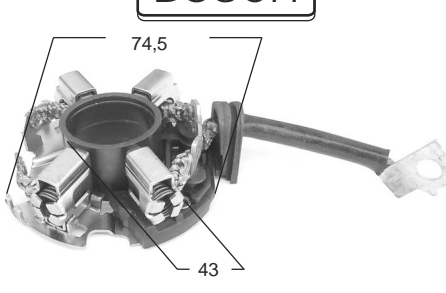

P2236C
ARR. BOSCH BMW, M. BENZ, ALFA ROMEO
5.8 x 18 x 14.5

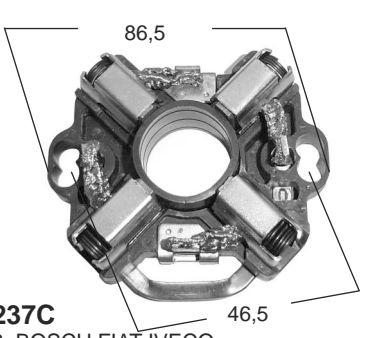

P2237C
ARR. BOSCH FIAT IVECO
7.5 x 17.5 x 17 ANTI - HORARIO



P2238C
ARR. BOSCH ANTI - HORARIO
4.8 x 15.7 x 13
(1 004 336 811)

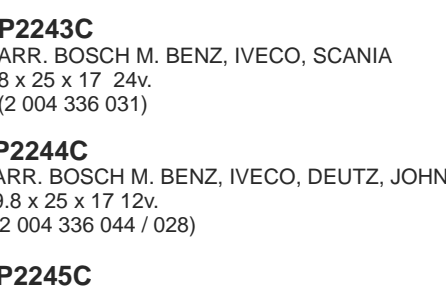

P2243C
ARR. BOSCH M. BENZ, IVECO, SCANIA
8 x 25 x 17 24v.
(2 004 336 031)

P2244C
ARR. BOSCH M. BENZ, IVECO, DEUTZ, JOHN DEERE
9.8 x 25 x 17 12v.
(2 004 336 044 / 028)

P2245C
ARR. BOSCH M. BENZ, DEUTZ, JOHN DEERE
8.7 x 16 x 17
(2 004 336 027 / 041)

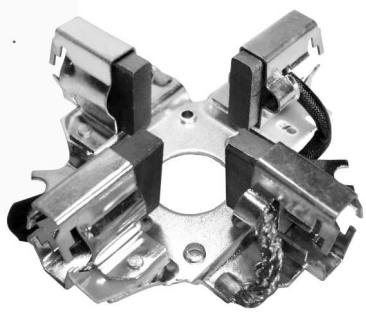
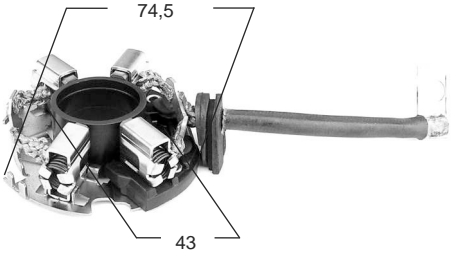
P2241C
ARR. BOSCH BMW, M. BENZ, ALFA ROMEO, AUDI, RENAULT. cable largo
5.8 x 17.5 x 14.5
(1 004 336 835 / 908 / 949)

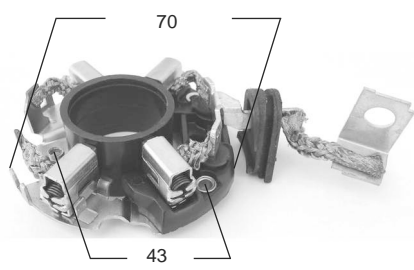

P2261C
ARR. BOSCH FIAT, OPEL, CHEVROLET
5 x 12 x 11.6 12v.
(1 004 336 957 F 000 AL 1 052)

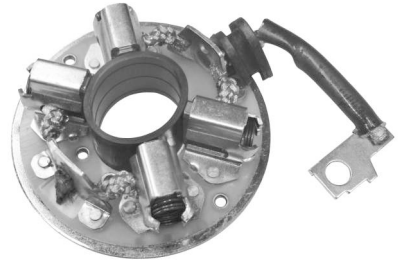

P2262C
ARR. BOSCH FIAT IVECO DAILY, FORD MOTOR MWM. 6 x 22 x 15 12v.
(6 033 AD0 368)

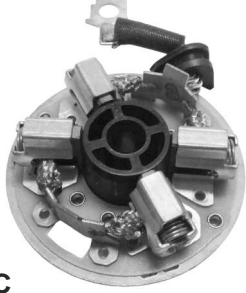

P2264C
ARR. BOSCH FORD 250 MOTOR CUMMINS
6 x 22 x 15.5 12v.
(6 033 AD0 409 / 370)

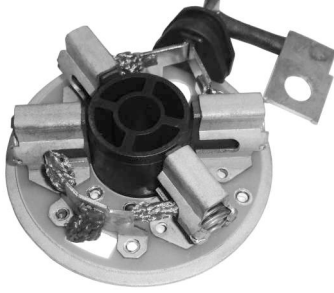

P2265C
ARR. BOSCH M. BENZ
6 x 22 x 15.5 24v.

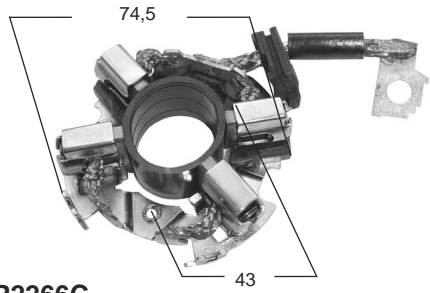

P2266C
ARR. BOSCH M. BENZ SPRINTER, CHEVROLET S10. 6 x 18 x 13.5 12v.

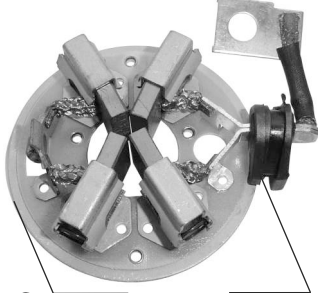

P2268C
ARR. BOSCH M. BENZ
6.5 x 25.5 x 16 24v.



P2270C
ARR. BOSCH NEW HOLLAND, DEUTZ, IVECO
10 x 22 x 24
(2 004 336 028 / 044)



P2272C
ARR. BOSCH AUTOELEVADOR
8.6 x 18.7 x 22

BOSCH



P2273C

ARR. BOSCH RENAULT KANGOO, SANDERO, LOGAN.
4.8 x 8.4 x 11.5

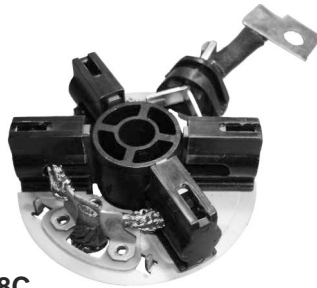

P2278C

ARR. BOSCH
5.5 X 18 X 28

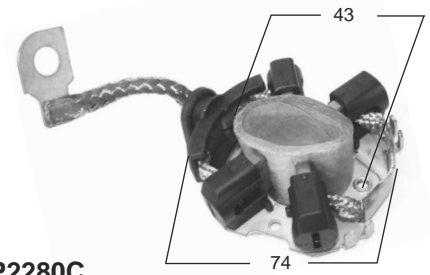

P2280C

ARR. BOSCH HORARIO 1.40 kw
6 x 18 x 12.5 12v.
(1 004 336 602 / 769)

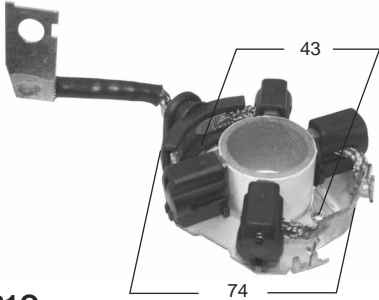

P2281C

ARR. BOSCH (R) 2.00 kw
5.9 x 18 x 14.5 12v. colilla 42 mm.

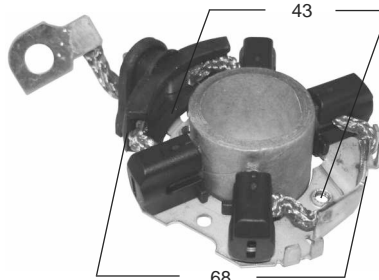

P2282C

ARR. BOSCH (R) 2.00 kw
5 x 13 x 15.5 12v. colilla 42 mm.



P2283C

ARR. BOSCH (R) 1.10 kw
4.5 x 12 x 11 12v. colilla 34 mm.



P2298C

ARR. BOSCH, CITROEN BERLINGO
PEUGEOT 206 5 x 16 x 13,5 12v. Colilla 36 mm.



P2299C

ARR. BOSCH, BMW, FIAT, PEUGEOT 206,
VOLVO 5 x 16 x 13,5 12v. Colilla 42 mm.



P2301C

ARR. BOSCH, FORD, IVECO,
TOYOTA HILUX. 6 18 14,5



P2303C

ARR. BOSCH 5 x 16 x 13 12v.



P2304C

ARR. BOSCH 5 x 12 x 11 12v.

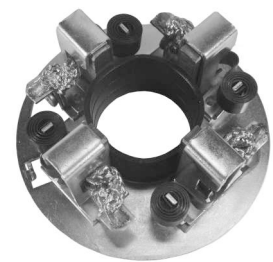

P2336C

ARR. BOSCH JE, SCANIA
8.8 x 35.7 x 18 24v.
(2 004 336 077 / 078)

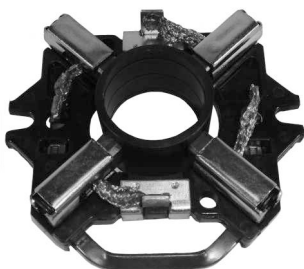

P2374C

ARR. BOSCH CITROEN, FIAT, FORD,
PEUGEOT, RENAULT, VW.
6.8 x 10 x 14.5 12v.



P2375C

ARR. BOSCH GOLF TURBO DIESEL, AUDI,
OPEL, ESCORT, TRANSPORTER
7 x 16 x 15

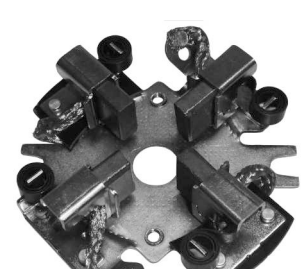

P2397C

ARR. BOSCH AUDI, VW, CHEVROLET, FORD
6.8 x 15.8 x 18

BOSCH



P2410C
PORTAESCOBILLAS ARRANQUE TIPO BOSCH

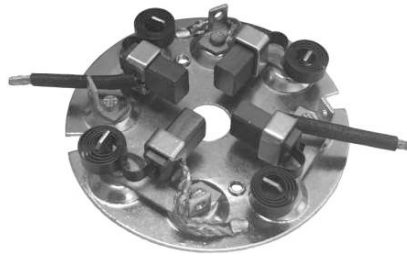

P2411C
PORTAESCOBILLAS ARRANQUE TIPO BOSCH

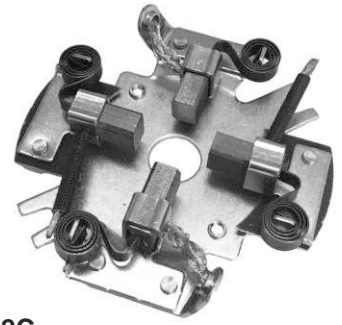

P2412C
PORTAESCOBILLAS ARRANQUE TIPO BOSCH



P2413C
PORTAESCOBILLAS ARRANQUE TIPO BOSCH



P2414C
PORTAESCOBILLAS ARRANQUE TIPO BOSCH



P2415C
PORTAESCOBILLAS ARRANQUE TIPO BOSCH

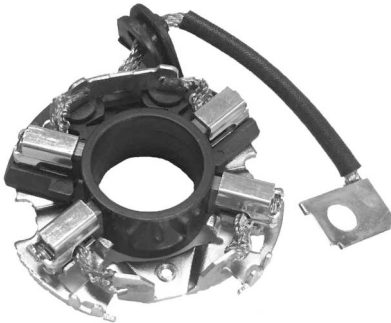

P2416C
PORTAESCOBILLAS ARRANQUE TIPO BOSCH



P2417C
ARR. BOSCH TOYOTA COROLLA
4.8 x 11.8 x 11.5



P2418C
ARR. BOSCH ALFA ROMEO, AUDI, CITROEN,
PEUGEOT, RENAULT, VW
4.8 x 11.8 X 11.5



P2419C
ARR. BOSCH FIAT UNO, PALIO, SIENA
4.8 x 11.8 x 11.5



P2420C
ARR. BOSCH
4,5 x 16 x 12 12V.

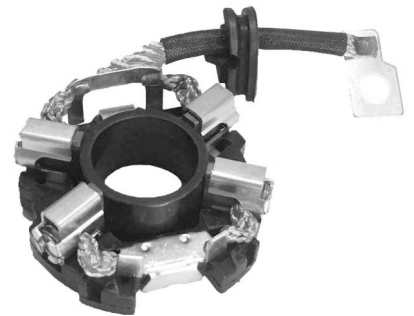

P2421C
PORTAESCOBILLAS ARRANQUE TIPO BOSCH

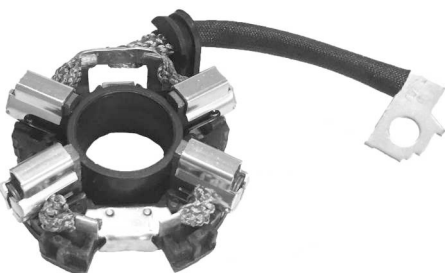

P2422C
PORTAESCOBILLAS ARRANQUE TIPO BOSCH

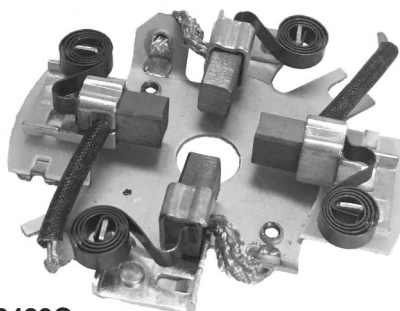

P2423C
PORTAESCOBILLAS ARRANQUE TIPO BOSCH



P2424C
PORTAESCOBILLAS ARRANQUE TIPO BOSCH

BOSCH

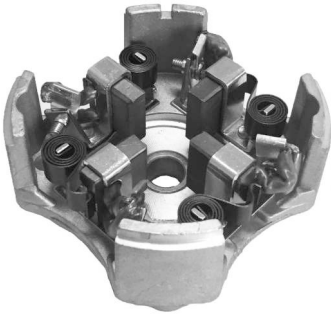

P2425C
PORTAESCOBILLAS ARRANQUE TIPO BOSCH



P2426C
PORTAESCOBILLAS ARRANQUE TIPO BOSCH



P2427C
ARR. BOSCH
6 x 18 x 14 12V.



P2428C
ARR. BOSCH
6 x 18 x 15,5 12V.



P2429C
ARR. BOSCH
6 x 18 x 15,5 12V.

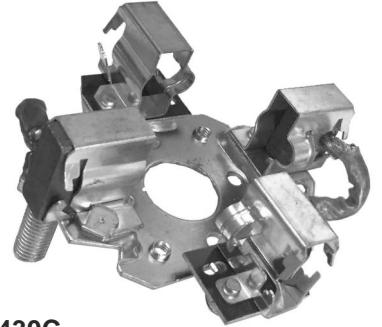

P2430C
PORTAESCOBILLAS ARRANQUE TIPO BOSCH



P2431C
PORTAESCOBILLAS ARRANQUE TIPO BOSCH



P2432C
PORTAESCOBILLAS ARRANQUE TIPO BOSCH



P2433C
PORTAESCOBILLAS ARRANQUE TIPO BOSCH



P2434C
PORTAESCOBILLAS ARRANQUE TIPO BOSCH

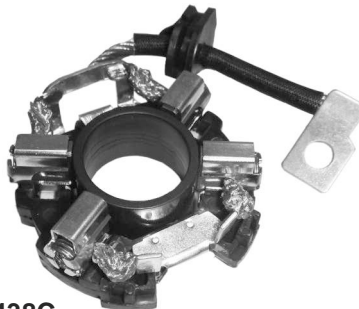

P2438C
ARR. BOSCH
5 x 16 x 13 12V.

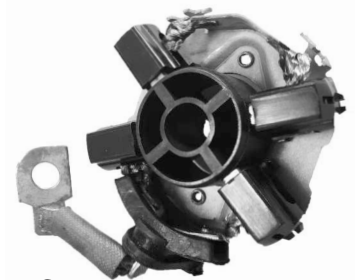

P2439C
ARR. BOSCH, FORD CARGO 2422/2626/2628
MOTOR CUMMINS ELECTRONICO
6 x 18 x 14,5 24v.



P2441C
PORTAESCOBILLAS ARRANQUE TIPO BOSCH



P2442C
PORTAESCOBILLAS ARRANQUE TIPO BOSCH



P2443C
PORTAESCOBILLAS ARRANQUE TIPO BOSCH

BOSCH



P2444C
PORTAESCOBILLAS ARRANQUE TIPO BOSCH

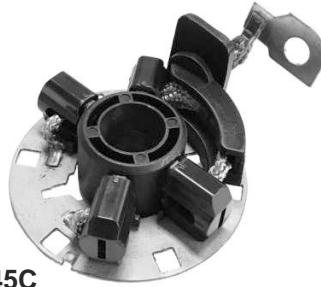

P2445C
PORTAESCOBILLAS ARRANQUE TIPO BOSCH

DELCO REMY

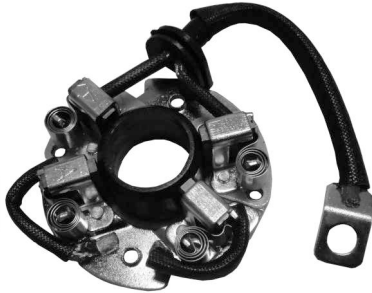

P2131C
ARR. DELCO REMY
5 x 18 x 15



P2136C
ARR. DELCO CHEVROLET BLAZER
PG100, 200, 250 C/REDUCCION 6.6 x 22 x 15



P2138C
ARR. DELCO FORD F-100 / 150,
POWERSTROKE 2.5 / 3.5 kw.
8.5 x 19 x 18

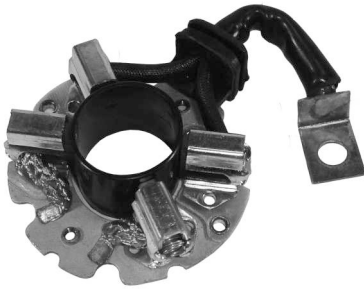

P2148C
ARR. DELCO PEUGEOT 206
4.8 x 18 x 14.7 colilla corta



P2150C
ARR. DELCO PEUGEOT 206
4.8 x 18 x 14.7 colilla larga



P2154C
ARR. DELCO PEUGEOT 206
4.8 x 18 x 14.7 colilla larga

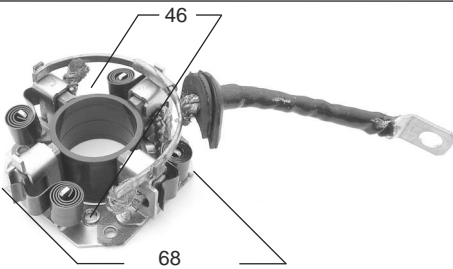

P2248C
ARR. DELCO CHEVROLET BLAZER
6 x 19 x 16
(10475602)



P2249C
ARR. DELCO CHEVROLET, ASTRA, BLAZER,
VECTRA. 5 x 15 x 12.5
(10452368)

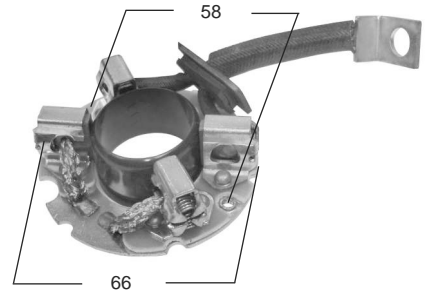

P2267C
ARR. DELCO CHEVROLET
4.7 x 13 x 15.8 (10453748)



P2275C
ARR. DELCO CHEVROLET, ISUZU
4.8 x 15.8 x 11



P2285C
ARR. DELCO 5MT, SD200 - 250
6.5 x 16 x 13



P2294C
ARR. DELCO 39 MT
9.5 x 32 x 22

DELCO REMY



P2296C

ARR. DELCO 29 MT, CAMIÓN
8 x 21 x 18 12v

P2297C

ÍDEM 24v

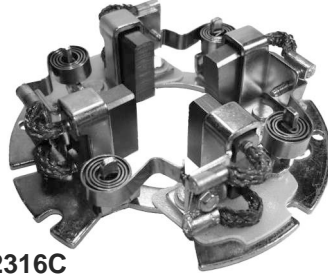

P2316C

ARR. DELCO 37MT, CAMIÓN CHEVROLET
CON MOTOR CUMMINS Y CATERPILLAR
9.5 x 28.5 x 24

P2316/1

ÍDEM SIN
CARBÓN

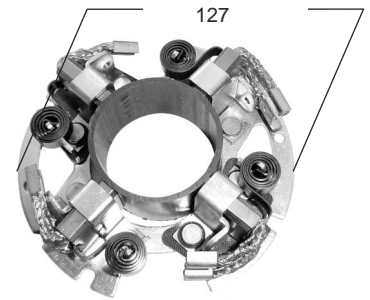

P2320C

ARR. DELCO 37 MT, M.BENZ, FORD, VW
9.7 x 29 x 25.5 12v (10468705)

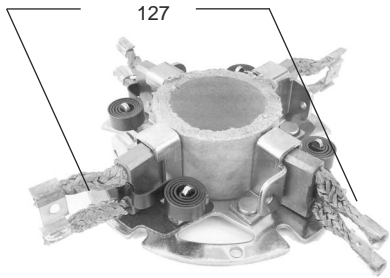

P2321C

ARR. DELCO 37 MT, M.BENZ, FORD, VW
9.7 x 29 x 25.5 24v (10469238)



P2322C

ARR. DELCO 42 MT, M.BENZ, FORD CARGO
MOTOR CUMMINS 6 CILINDROS
9.7 x 36.7 x 26 12v (1988121)

P2322/1

ÍDEM SIN
CARBÓN



P2323C

ARR. DELCO 42 MT, FORD MOTOR CUMMINS
10.5 x 36.5 x 24.5 24v

P2324C

ARR. DELCO 41 MT, MASSEY FERGUSON,
CATERPILLAR
9.7 x 28.7 x 25 12v

P2324C/24

ARR. DELCO 41 MT, M.BENZ
9.7 x 28.7 x 25 24v

P2324/1

ÍDEM SIN CARBONES

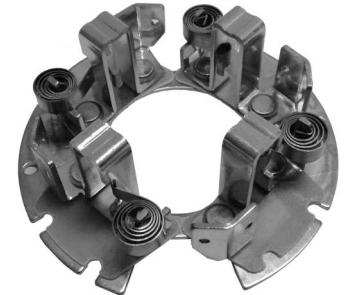

P2325/1

ARR. DELCO 42 MT, CUMMINS, M.BENZ



P2326/1

ARR. DELCO 37 Y 41 MT,
MASA AISLADA CUMMINS

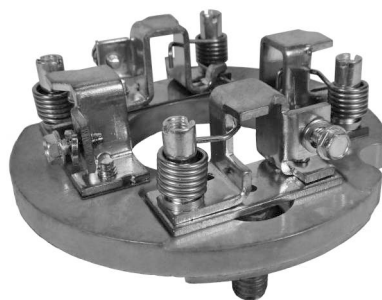

P2327/1

ARR. DELCO 35 MT, CHEVROLET



P2328/1

ARR. DELCO 37 MT, M.BENZ,
FORD MODELO VIEJO

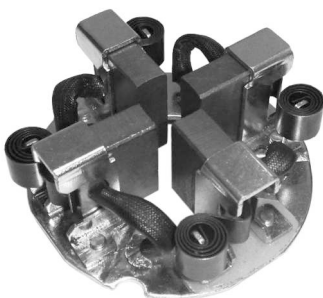

P2330C

ARR. DELCO 38 MT 9,5 x 28 x 23 24v.

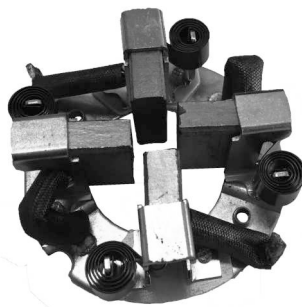

P2331C

ARR. DELCO REMY 38MT 12v. 9.5x28x23



P2332/1

ARR. DELCO 50 MT CATERPILLAR,
JOHN DEERE

DELCO REMY

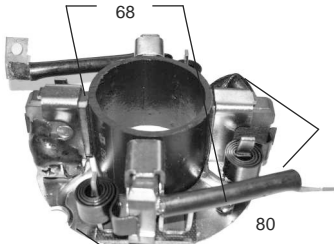

P2333C

ARR. DELCO 28 MT
2.9 kW - 7.7 x 25 x 21 12v
(10456456)

P2333/1
ÍDEM SIN
CARBÓN

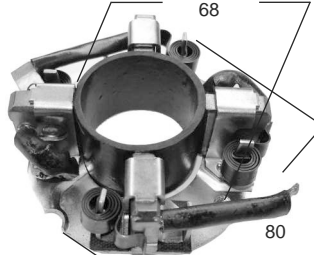

P2334C

ARR. DELCO 28 MT 3.96 kW
7.8 x 25 x 20 24v (10483823)



P2335C

ARR. DELCO 39 MT
FIAT MOTOR CUMMINS
9.5 x 32 x 22

P2335C/24
ÍDEM 24v

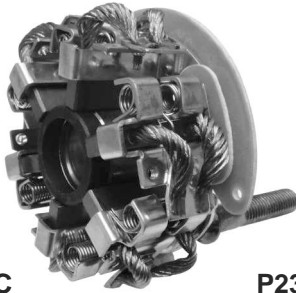

P2337C

ARR. DELCO 50 MT
8 x 38 x 21 (6 carbones)

P2337/1
ÍDEM SIN
CARBÓN

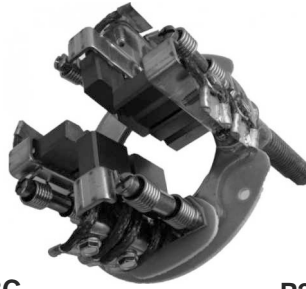

P2338C

ARR. DELCO 40 MT
9.5 x 19 x 19 (8 carbones)

P2338/1
ÍDEM SIN
CARBÓN



P2339C

ARR. DELCO PG100
5,5 x 14,4 x 14,8



P2366C

PORTAESCOBILLAS ARRANQUE TIPO
DELCO REMY - NIPPONDENSO



P2389C

PORTAESCOBILLAS ARRANQUE TIPO
DELCO REMY



P2390C

PORTAESCOBILLAS ARRANQUE TIPO
DELCO REMY



P2391C

PORTAESCOBILLAS ARRANQUE TIPO
DELCO REMY



P2392C

PORTAESCOBILLAS ARRANQUE TIPO
DELCO REMY



P2393C

PORTAESCOBILLAS ARRANQUE TIPO
DELCO REMY



P2394/1

PORTAESCOBILLAS ARRANQUE TIPO
DELCO REMY

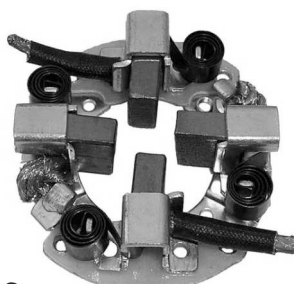

P2408C

PORTAESCOBILLAS ARRANQUE TIPO
DELCO REMY - NIPPONDENSO -
MAGNETI MARELLI

FORD / MOTORCRAFT



P2153C
ARR. MOTORCRAFT, LINEA DD, FORD 4.9,
MITSUBISHI L200 4.3 x 12 x 14



P2155C
ARR. MOTORCRAFT, FORD EXPLORER,
ESCORT - 4.5 x 16 x 16



P2156/1
ARR. MOTORCRAFT, FORD RANGER - F150

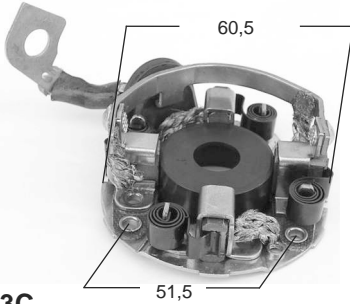

P2223C
ARR. MOTORCRAFT, FORD KA
6 x 13 x 13.5



P2224C
ARR. MOTORCRAFT, FORD TRANSIT, F100,
COURIER. 8 x 19 x 22 (F7RU11434BA)

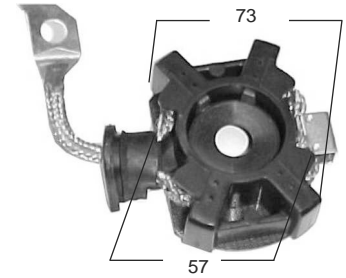

P2308C
ARR. MOTORCRAFT, FORD MONDEO
4.6 x 16 x 14 (F3RZ11002C)

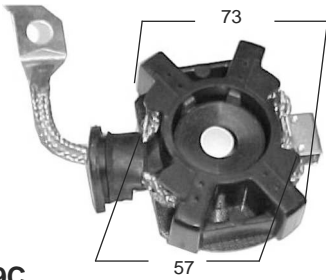

P2309C
ARR. MOTORCRAFT, ESCORT, FIESTA, KA,
F100, MONDEO 4.6 x 16 x 14
(E90Z-11061A/B/C)



P2376C
ARR. MOTORCRAFT, RANGER, F100 - 150,
EXPLORER, TRANSIT, COURIER
4.5 x 16 x 16

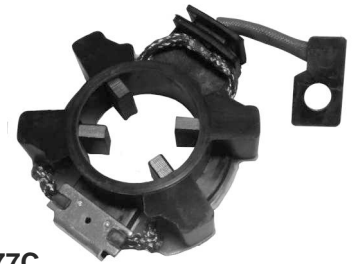

P2377C
ARR. MOTORCRAFT, FORD EURO
4.8 x 13 x 12 12v.



P2378C
ARR. MOTORCRAFT FORD
6 x 13 x 14.



P2387C
PORTAESCOBILLAS ARRANQUE
TIPO MOTORCRAFT

HITACHI

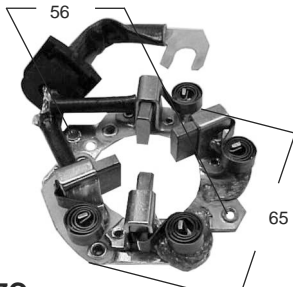

P2137C
ARR. HITACHI, ESCORT, POLO
POINTER, R19 - 4.5 x 14 x 15.5 (352 58 566)



P2157C
ARR. HITACHI, ISUZU, NISSAN DIESEL
7 x 19 x 15.8



P2158C
ARR. HITACHI, KOMATSU, NISSAN, DAIHATSU,
ISUZU, TOYOTA
7.8 x 25 x 20

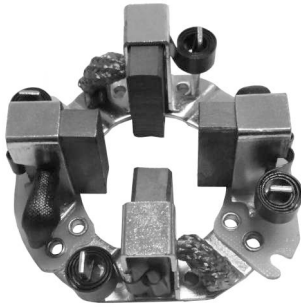

P2159C
ARR. HITACHI 10 x 35 x 22



P2160C
ARR. HITACHI TATA SUMO 8 x 25 x 20



P2161C
ARR. HITACHI 7 x 25 x 16



P2162C
ARR. HITACHI AUTOELEVADOR NISSAN,
DATSUN 2.5 kw - 10 x 28 x 21



P2163C
ARR. HITACHI 7 x 11 x 16

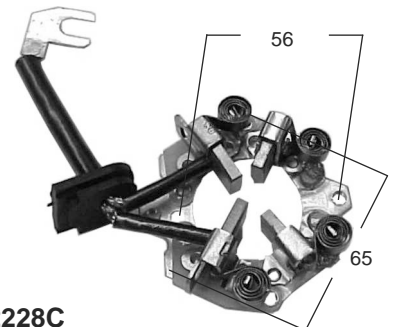

P2228C
ARR. HITACHI, CORSA - ASTRA DIESEL
4.5 x 14 x 15.5 (352 58 566)

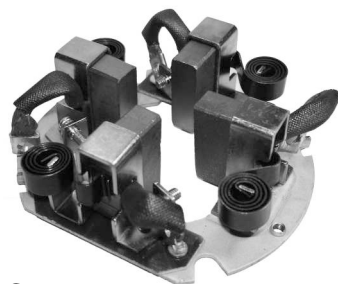

P2276C
ARR. HITACHI AUTOELEVADOR NISSAN
10 x 30 x 22

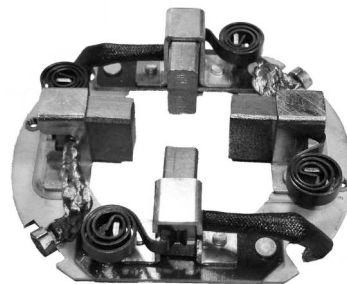

P2277C
ARR. HITACHI NISSAN, ISUZU
9 x 19.5 x 22



P2289C
ARR. HITACHI, VW GOLF, YAMAHA
5.5 x 13.5 x 26.5

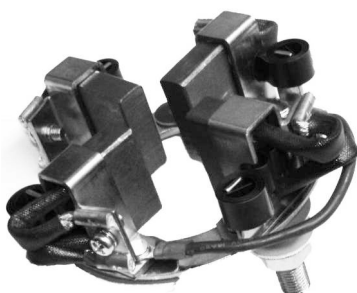

P2295C
ARR. HITACHI
10 x 22 x 32



P2314C
ARR. HITACHI, ISUZU, KOMATSU, NISSAN
7 x 19.5 x 15



P2315C
ARR. HITACHI, ISUZU, NISSAN, TOYOTA
6.8 x 14 x 15. 12v.

HITACHI



P2350C
ARR. HITACHI AUTOELEVADOR
4.5 x 12 x 12.5

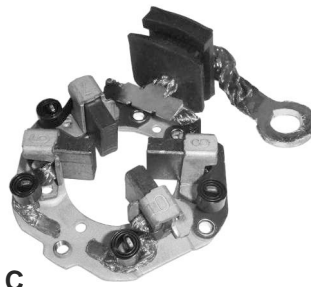

P2351C
ARR. HITACHI 5,5 x 14,4 x 14,8



P2405C
PORTAESCOBILLAS ARRANQUE
TIPO HITACHI

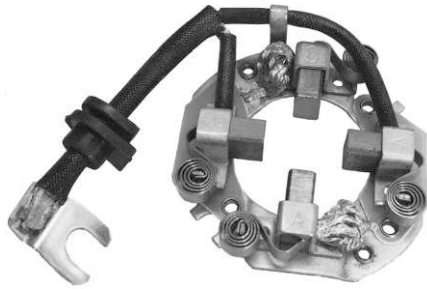

P2407C
PORTAESCOBILLAS ARRANQUE
TIPO HITACHI



P2475C
ARR. HITACHI 4.5 x 12 x 13

INDIEL

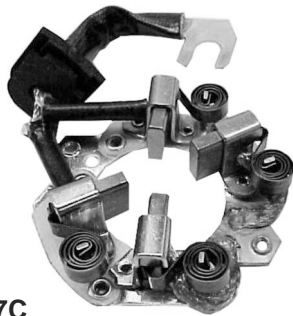

P2137C
PORTAESCOBILLAS ARRANQUE
TIPO HITACHI - INDIEL

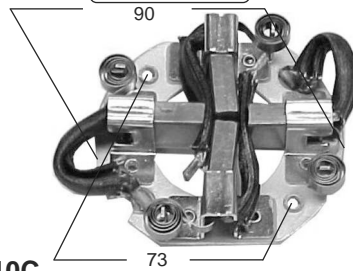

P2210C
ARR. INDIEL M50, M115, M127,
FORD CON MOTOR MAXION - MWM
9 x 20.5 x 24.5

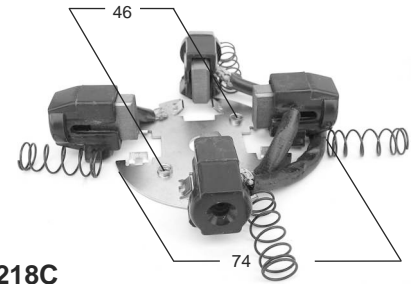

P2218C
ARR. INDIEL M93R, MOTOR MAXION
(casillero baquelita) 8 x 19 x 18
(352 58 637)

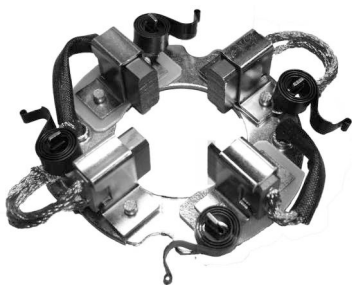

P2284C
ARR. LUCAS M50, M127
9 x 20 x 24



P2287C
ARR. INDIEL 8 x 18 x 13

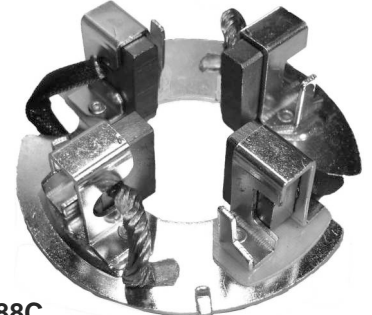

P2288C
ARR. INDIEL, M. BENZ MOTOR CUMMINS -
MWM - 8 x 25 x 16

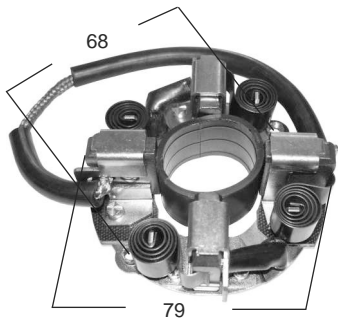

P2395C
ARR. INDIEL 7.8 x 24.8 x 21 (K-01260)



P2396C
ARR. INDIEL, TRANSIT
7.8 x 24.5 x 21 12v (K-01236)

ISKRA

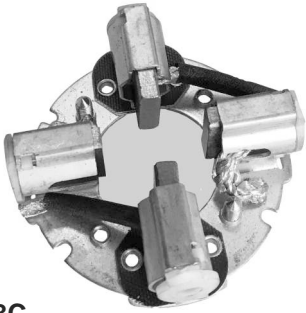

P2178C
PORTAESCOBILLAS ARRANQUE TIPO ISKRA

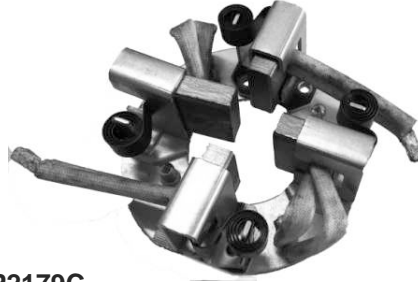

P2179C
PORTAESCOBILLAS ARRANQUE TIPO ISKRA

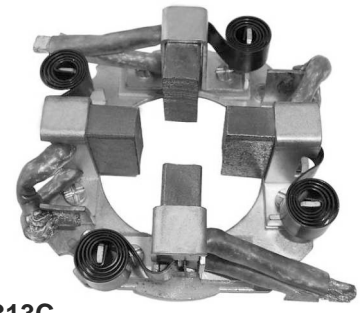

P2313C
PORTAESCOBILLAS ARRANQUE TIPO ISKRA

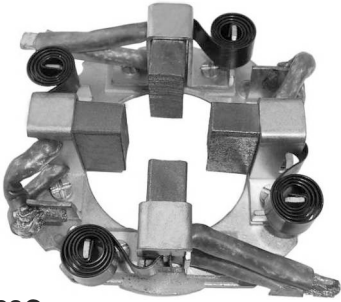

P2388C
PORTAESCOBILLAS ARRANQUE TIPO ISKRA

MARELLI



P2151C
ARR. MARELLI, FIAT 150 - 800
10 x 25 x 23 24v.

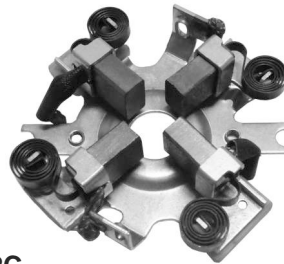

P2152C
ARR. MARELLI, FIAT DUCATO, IVECO, ALLIS
9 x 16 x 23.5.

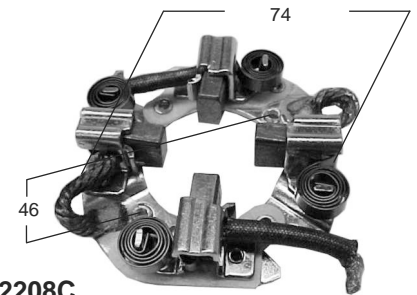

P2208C
ARR. MARELLI, FIAT UNO, DUNA,
RENAULT 11/12/18/19/21, TRAFIC
7 x 13 x 18 (F3RZ-11002C - F3RZ11061C)

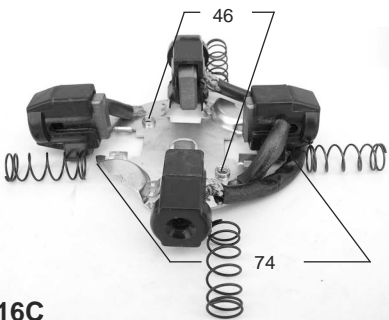

P2216C
ARR. MARELLI, FIAT DUCATO
8 x 19 x 18 (855 403 41) (casillero baquelita)

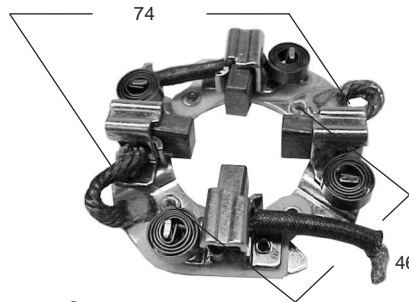

P2222C
ARR. MARELLI, FIAT DUNA NAFTERO
7 x 13 x 18

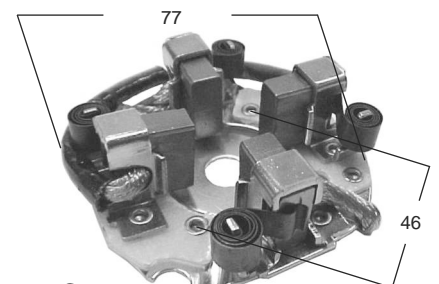

P2230C
ARR. MARELLI, DUCATO, BOXER, BERLINGO
8 x 19 x 20

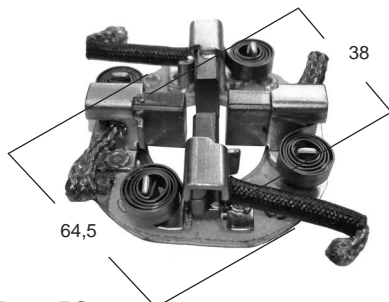

P2235C
ARR. MARELLI, FIAT PALIO - SIENA,
6 x 14.8 x 19

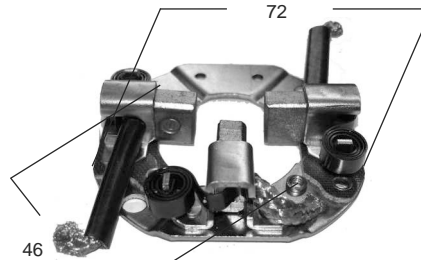

P2240C
ARR. MARELLI, PALIO - SIENA
7 x 13 x 17.8
(17 5832 244 61 *832 253 26)

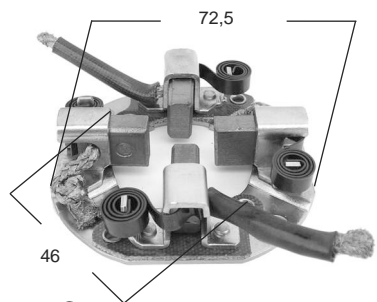

P2242C
ARR. MARELLI, FIAT TIPO, PALIO SIENA
7 x 13 x 17.5 (832 212 41)

MARELLI

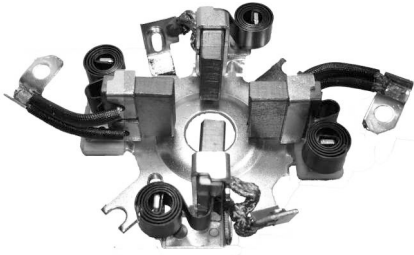

P2279C
ARR. MARELLI, FIAT, MT 67
8 x 25 x 23

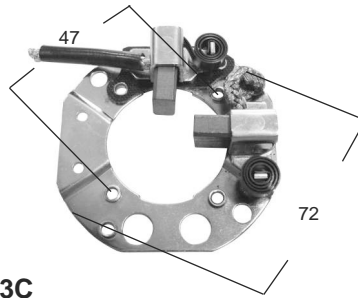

P2343C
ARR. MARELLI, SIENA, PALIO
7 x 13 x 17.5 (9945553)

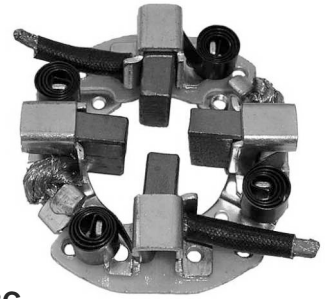

P2408C
PORTAESCOBILLAS ARRANQUE TIPO DELCO
REMY - NIPPONDENSO - MAGNETI MARELLI

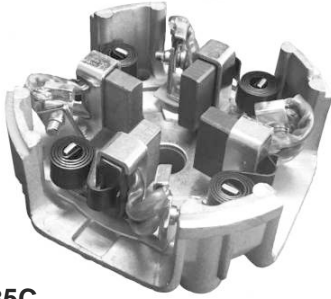

P2435C
PORTAESCOBILLAS ARRANQUE TIPO
MAGNETI MARELLI

MITSUBISHI

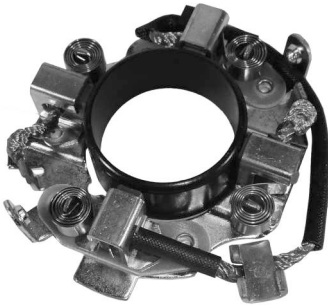

P2135C
ARR. MITSUBISHI CON GUIA - 6.8 x 15 x 15



P2143C
ARR. MITSUBISHI PAJERO TR4, CHRYSLER
4,5 x 12 x 12,5 12 v.



P2149C
ARR. MITSUBISHI, HYUNDAI: ELANTRA,
DODGE: 81-94, 5 x 10,6 x 12,5 12v.

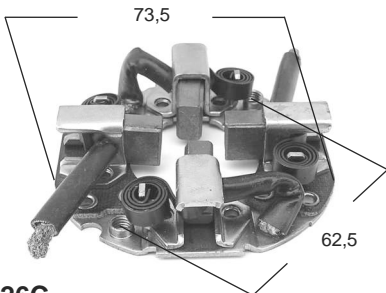

P2226C
ARR. MITSUBISHI, CORSA, ISUZU, NISSAN,
PICK UP, LUV, SENTRA. 7 x 12 x 17.5
(M649X20471 ME701467)



P2225C
ARR. MITSUBISHI, PEUGEOT 405
4.5 x 18 x 17

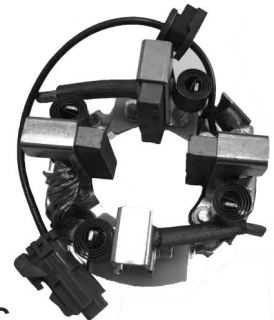

P2181C
ARR. MITSUBISHI VOLVO: B12, FM12, FH 12,
8 x 30 x 18,2 24v.



P2226C/24
ARR. MITSUBISHI, ISUZU, NISSAN
7 x 12 x 17.5 (M649X20771 ME701495)

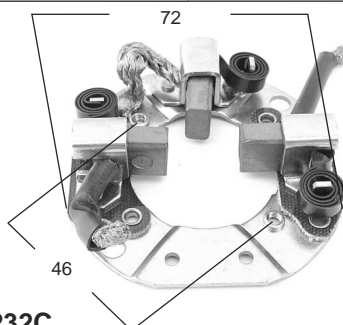

P2232C
ARR. MITSUBISHI, TOYOTA
7 x 10 x 16 (3 carbones) (M649T04471)

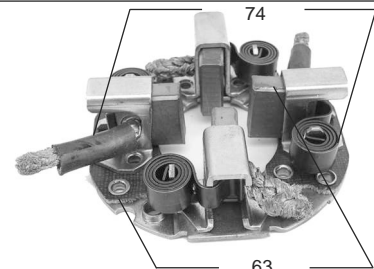

P2239C
ARR. MITSUBISHI, MAZDA,
NISSAN, DATSUN. 7x18x18.5 12v. (M649T05072
ME700127)

P2239C/24
IDEM 24v.
(M649T05072
ME700140)

MITSUBISHI

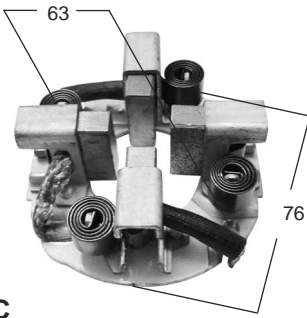

P2246C
ARR. MITSUBISHI, FORD VAN
8 x 24 x 18 12v (F4TZ-11061-A SBE-351)

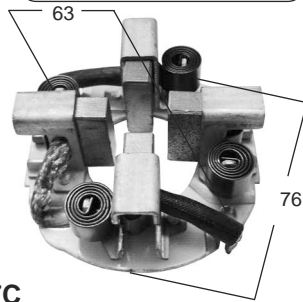

P2247C
ARR. MITSUBISHI, FORD VAN
8 x 24 x 18 24v.

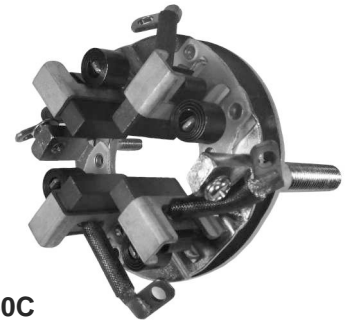

P2250C
ARR. MITSUBISHI, CAMIONES Y MICROS
DX157-158 - 8 x 24.5 x 20

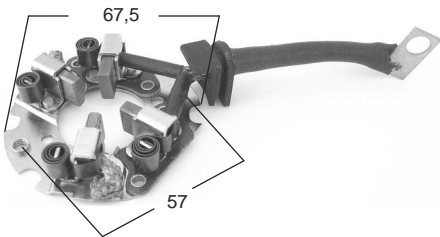

P2255C
ARR. MITSUBISHI CHRYSLER, DODGE,
NISSAN. 4.5 x 11 x 19
(M649T01271 Md611217) (colilla corta)



P2256C
ARR. MITSUBISHI CHRYSLER, DODGE,
NISSAN. 4.5 x 11 x 19
(colilla larga)

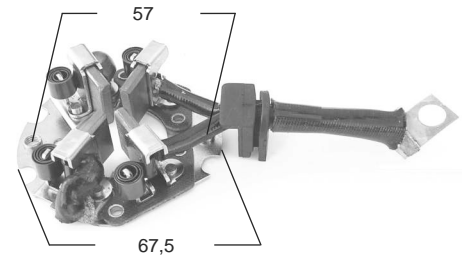

P2257C
ARR. MITSUBISHI, CHEVROLET, FORD,
SUZUKI. 4.5 x 18 x 17 12v.
(F32Z-11061-B SBE-342 835 036 71-colilla corta)

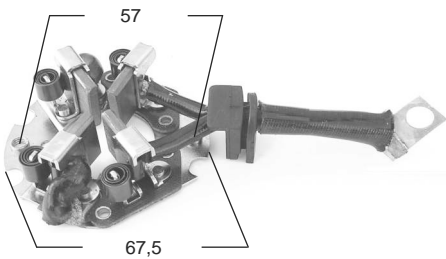

P2258C
ARR. MITSUBISHI, CHEVROLET, FORD,
SUZUKI. 4.5 x 18 x 17 12v.
(colilla larga)

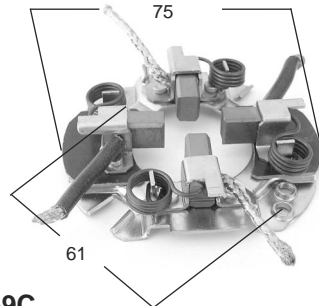

P2259C
ARR. MITSUBISHI, CLARK, MAZDA, NISSAN
7 x 10 x 16 (M649T04471 MD607420)

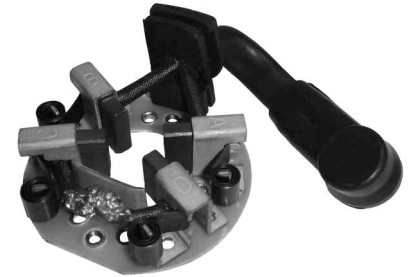

P2271C
ARR. MITSUBISHI, ISUZU, HONDA ACURA
5 x 17 x 16



P2291C
ARR. MITSUBISHI
7 x 12 x 17.5

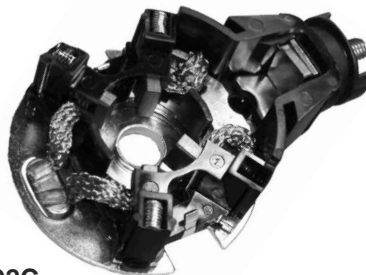

P2292C
ARR. MITSUBISHI, HONDA ACURA
4.7 x 12 x 11.5

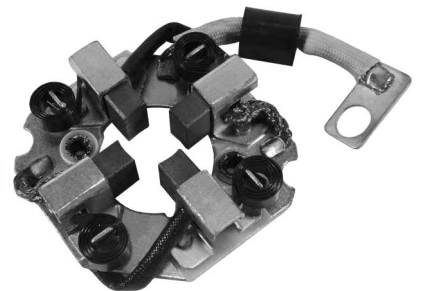

P2329C
ARR. MITSUBISHI
7 x 14 x 16.5



P2347C
ARR. MITSUBISHI, VW VOLVO
8 x 30 x 17.5 24v.



P2348C
ARR. AUTOELEVADOR MITSUBISHI
4.5 x 12 x 12.5 12 v.
(colilla larga)



P2349C
ARR. AUTOELEVADOR MITSUBISHI
4.5 x 12 x 12.5 (colilla corta)

MITSUBISHI



P2350C
PORTAESCOBILLAS ARRANQUE TIPO
HITACHI - MITSUBISHI

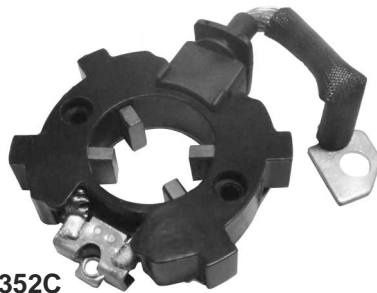

P2352C
ARR. MITSUBISHI
4.4 x 12 x 12.5

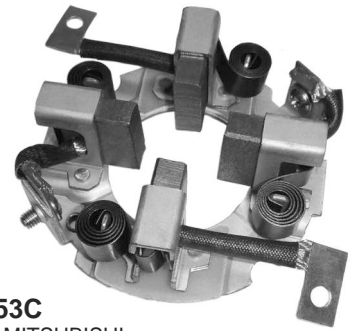

P2353C
ARR. MITSUBISHI
8 x 24 x 20,5



P2354C
ARR. MITSUBISHI
9 x 30 x 23

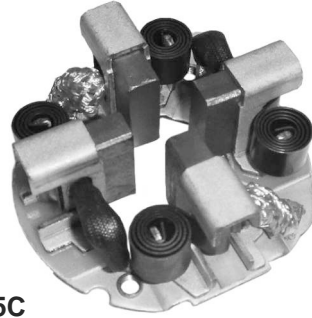

P2355C
ARR. MITSUBISHI
8 x 24 x 17,5



P2398C
PORTAESCOBILLAS ARRANQUE
TIPO MITSUBISHI



P2399C
PORTAESCOBILLAS ARRANQUE
TIPO MITSUBISHI



P2400C
PORTAESCOBILLAS ARRANQUE
TIPO MITSUBISHI



P2401C
PORTAESCOBILLAS ARRANQUE
TIPO MITSUBISHI

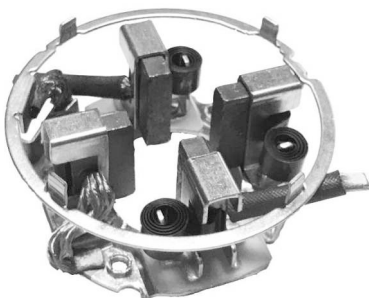

P2447C
PORTAESCOBILLAS ARRANQUE
TIPO MITSUBISHI

NIPPONDENSO



P2139C
ARR. NIPPONDENSO, HONDA, TOYOTA,
DAIHATSU 6.8 x 15.8 x 15.7

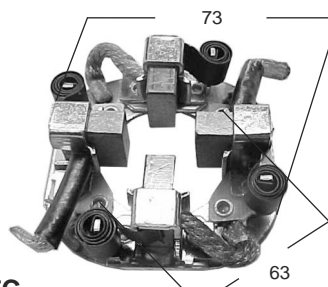

P2217C
ARR. NIPPONDENSO, MITSUBISHI, MAZDA,
HONDA, ISUZU 8 x 19 x 18

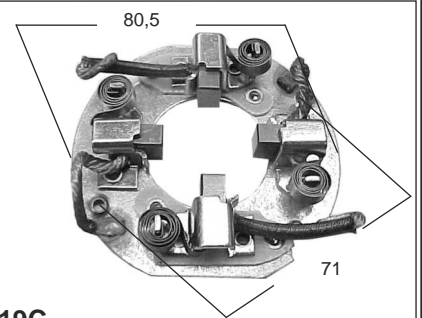

P2219C
ARR. NIPPONDENSO, HONDA, ISUZU,
DATSUN 6.8 x 11 x 19

NIPPONDENSO

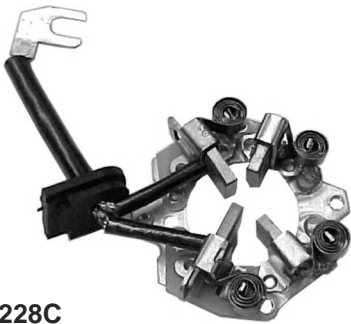

P2228C
PORTAESCOBILLAS ARRANQUE TIPO NIPPONDENSO

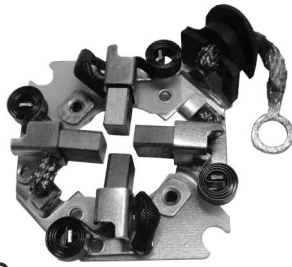

P2251C
PORTAESCOBILLAS ARRANQUE TIPO NIPPONDENSO

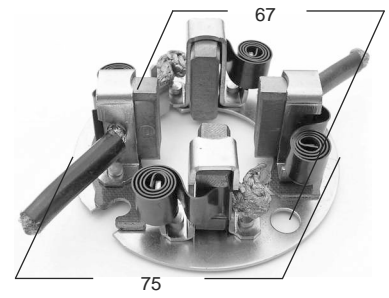

P2252C
ARR. NIPPONDENSO, ISUZU, CHEVROLET, DODGE 7.8 x 25 x 15

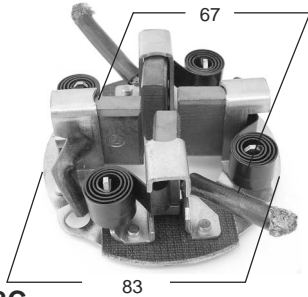

P2253C
ARR. NIPPONDENSO, KUBOTA, TOYOTA, KOMATSU 7.8 x 25 x 21 (28140-77090)

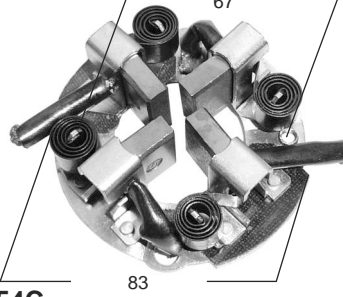

P2254C
ARR. NIPPONDENSO, KUBOTA, TOYOTA, CASE. 7.8 x 25 x 21 24v(028510 0500)

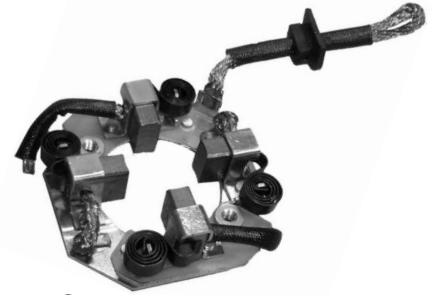

P2290C
ARR. NIPPONDENSO 7 x 14 x 16.4

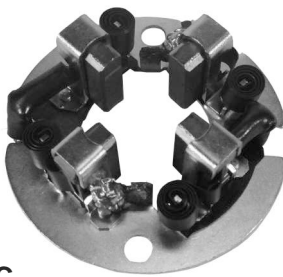

P2311C
ARR. NIPPONDENSO, KIA, DAIHATSU 8 x 25 x 15.5 12v.



P2312C
ARR. NIPPONDENSO, DODGE, TOYOTA 7 x 25 x 16



P2363C
ARR. NIPPONDENSO CATERPILLAR, CUMMINS CASE 12v. 10 x 30 x 21

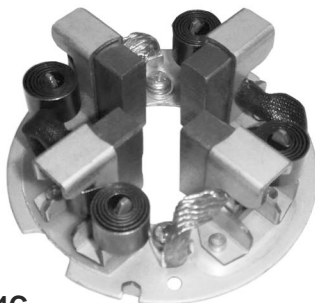

P2364C
ARR. NIPPONDENSO CATERPILLAR, CUMMINS CASE 24v. 10 x 30 x 21



P2365C
ARR. NIPPONDENSO, TOYOTA 4,5/7,5 x 8,5/10 x 16



P2366C
ARR. NIPPONDENSO ANTI HORARIO TOYOTA COROLLA 4,5/7,5 x 8,5/10 x 16

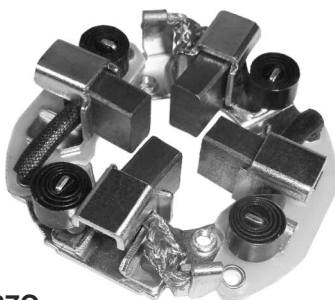

P2367C
ARR. NIPPONDENSO ISUZU, TOYOTA, SUZUKI, KUBOTA. 7 x 13 x 15,5

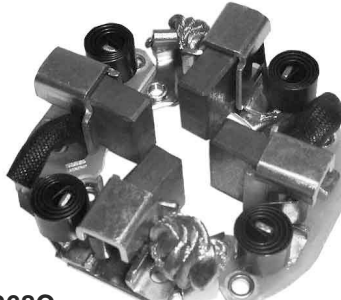

P2368C
ARR. NIPPONDENSO, FIAT PALIO, CHEVROLET, ISUZU, TOYOTA. 7 x 16 x 15,5

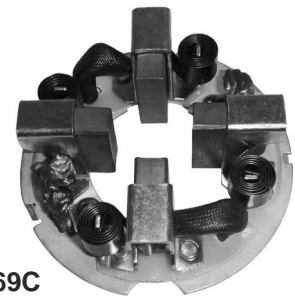

P2369C
ARR. NIPPONDENSO, CATERPILLAR, ISUZU, CUMMINS, CASE. 9.8 x 30 x 21 12v.

NIPPONDENSO

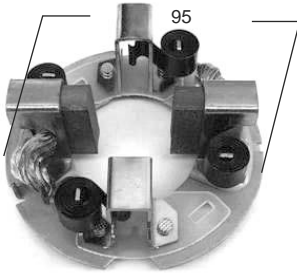

P2370C
ARR. NIPPONDENSO, CATERPILLAR, CASE,
CUMMINS, ISUZU. 10 x 30 x 20
(028510-0880 181118-043-0 28140-1310A)

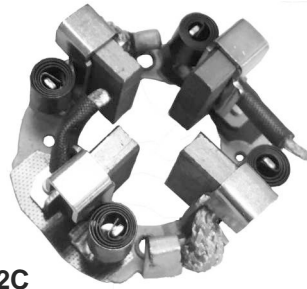

P2402C
PORTAESCOBILLAS ARRANQUE
TIPO NIPPONDENSO

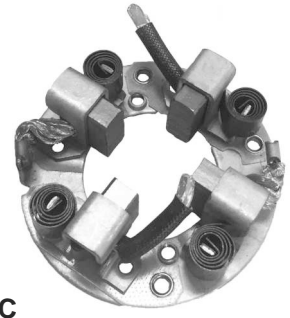

P2403C
PORTAESCOBILLAS ARRANQUE
TIPO NIPPONDENSO



P2404C
PORTAESCOBILLAS ARRANQUE
TIPO NIPPONDENSO

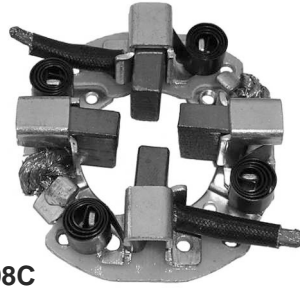

P2408C
ARR. NIPPONDENSO, CHRYSLER,
DODGE, ISUZU, TOYOTA
7 x 16 x 15.5 24v.

P2409C
IDEM 12v.



P2440C
PORTAESCOBILLAS ARRANQUE TIPO
NIPPONDENSO

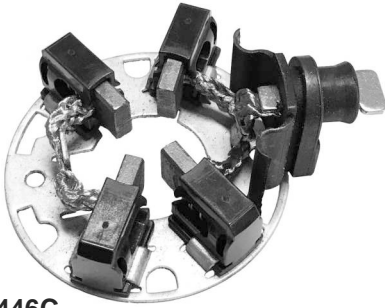

P2446C
PORTAESCOBILLAS ARRANQUE TIPO
NIPPONDENSO

PARIS RHONE



P2130
ARR. PARIS RHONE, PEUGEOT 405,
RENAULT 18 FUEGO



P2130C
ARR. PARIS RHONE, PEUGEOT 405,
RENAULT 18 FUEGO 9.7 / 4.2 x 12.4 x 15



P2169/1
ARR. PARIS RHONE PEUGEOT 405

TRIA

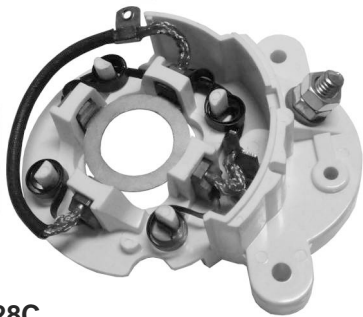

P2128C
ARR. TRIA, CHRYSLER, DODGE POLARA
CAJA AUTOMATICA 8.8 x 17.6 x 13



P2129C
ARR. TRIA, CHRYSLER
8.5 x 18 x 18

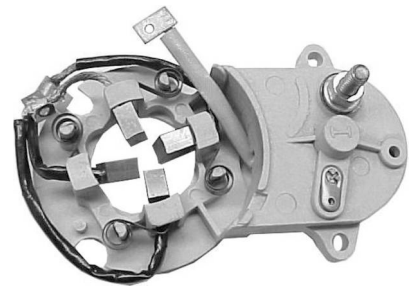

P2220C
ARR. TRIA, DODGE 1500 - 8.8 x 15 x 17.7

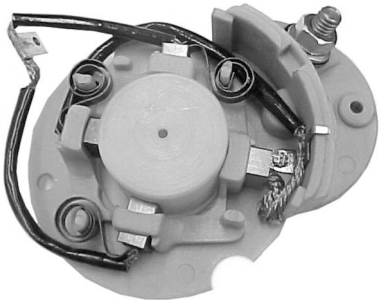

P2221C
ARR. TRIA, DODGE POLARA

VALEO



P2132C
ARR. VALEO, PEUGEOT 405,
RENAULT 19/21 - 9 / 4.6 x 11 x 17

P2132
IDEM SIN
CARBON

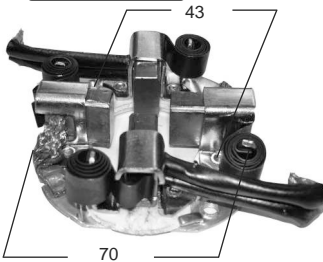

P2134C
ARR. VALEO, RENAULT TRAFIC DIESEL,
TRIO, EXPRESS. 9 x 22 x 18
(1 004 336 801 / 821 / 827 / 951 F 000 AL 1 051)

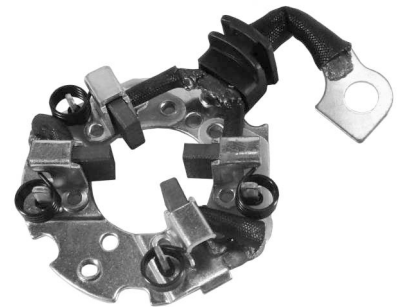

P2167C
ARR. MITSUBISHI 4.5 x 12 x 13



P2168/1
ARR. VALEO



P2169C
ARR. VALEO 7,5 x 12 x 15



P2170/1
ARR. VALEO



P2171/1
ARR. VALEO

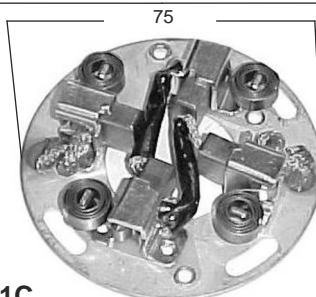

P2211C
ARR. VALEO, RENAULT 19, EXPRESS,
CLIO DIESEL, PEUGEOT 205/206/306/405
7 x 13 x 18



P2263C
ARR. VALEO, MASTER ELECTRONICO
7 x 12 x 10.5

VALEO



P2286C
ARR. VALEO 8 x 15.5 x 15



P2293C
ARR. VALEO 6.5 x 8 x 10

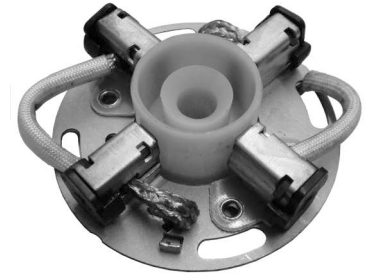

P2310C
ARR. VALEO, RENAULT, PEUGEOT DIESEL,
(ORIGINAL) 7 x 14 x 14

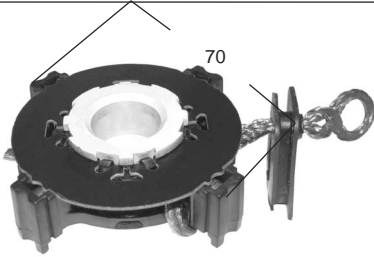

P2344C
ARR. VALEO, VW POLO, GOLF
6.5 x 8 x 11 (4 carbones, colilla 30 mm)
(594381)

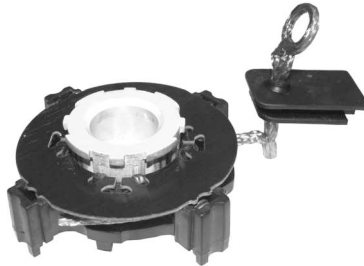

P2345C
ARR. VALEO, ESCORT, FIESTA, KA
6.5 x 8 x 11 (3 carbones, colilla 40 mm)
(594290)

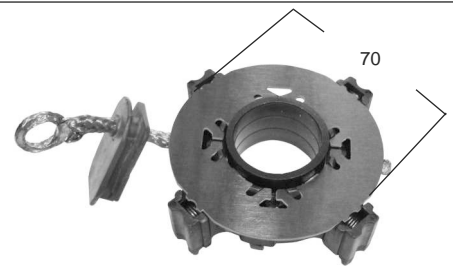

P2371C
ARR. VALEO, CHEVROLET, PEUGEOT,
RENAULT 6.5 x 8 x 11 (4 carb., colilla 38 mm)
(D7EUF1171/4) (594351)



P2373C
ARR. VALEO, PEUGEOT, RENAULT
6.5 x 8 x 10.5
(494 818)



P2379C
ARR. VALEO, M. BENZ, SPRINTER,
UNIMOG. 7 x 14 x 14



P2380C
ARR. VALEO, RENAULT, PEUGEOT.
7 x 14 x 14



P2381C
ARR. VALEO
3,16 / 6,68 x 10 x 15



P2382C
ARR. VALEO ANTIHORARIO
3,16 / 6,68 x 10 x 15

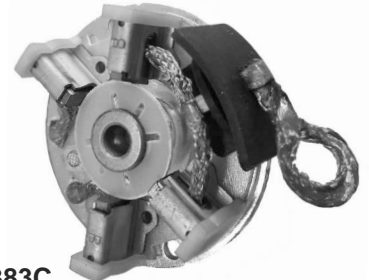

P2383C
ARR. VALEO NISSAN, CLIO, LOGAN,
SANDERO, ECOSPORT 2002-2012
5 x 12 x 11,6



P2384C
PORTAESCOBILLAS ARRANQUE
TIPO VALEO



P2385C
PORTAESCOBILLAS ARRANQUE
TIPO VALEO



P2386C
PORTAESCOBILLAS ARRANQUE
TIPO VALEO

P2501C
DIRECCION HIDRAULICA RENAULT
KANGOO, CLIO DIESEL. 5.6 x 12 x 19

VALEO

P2503C
DIRECCION HIDRAULICA RENAULT
AUTOELEVADORES VARIOS 6.6 x 12.1 x 19

P2165C
PORTAESCOBILLAS ARRANQUE
TIPO HONDA

MOTOS

P2166C
ARR. MOTO 5 x 9.8 x 12

P2173/1
ARR. MOTO 6.5 x 6.5 x 14

P2182C
ARR. MOTO HONDA BIZ 100 - 6 x 7,5 x 8 12v

P2317C
ARR. MOTO KAWASAKI, JET SKI
MOTOR 900/1100 cc - 5 x 10 x 12.5

P2318C
ARR. MOTO HONDA, YAMAHA 750
4.8 x 9.7 x 12.5 (31206 MMS 008 IVJ81844 000)

P2319C
ARR. MOTO HONDA CBX200 - XR200 -
NX200. 6 x 10 x 13.5 (31206)

P2340C
ARR. MOTO YAMAHA YBR 250
6 x 9.5 x 10

P2341C
ARR. MOTO HONDA TITAN CG150
5.9 x 7.3 x 8

P2342C
ARR. MOTO HONDA BIZ
6 x 7.3 x 8

P2448C
PORTAESCOBILLAS ARRANQUE
TIPO HONDA

VARIOS



P2151C
PORTAESCOBILLAS ARRANQUE TIPO
MAGNETI MARELLI - MAKO

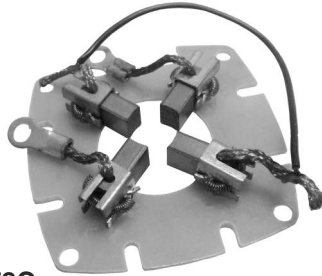

P2172C
PORTA ESCOBILLA ARR.
6.5 x 9.6 x 17

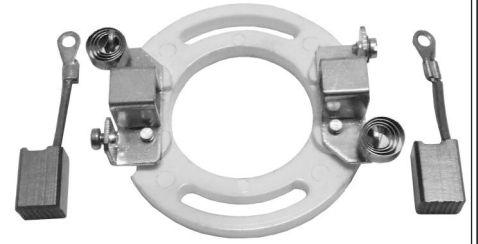

P2174C
ARR. MOTOR INDUSTRIAL
8 x 10 x 15



P2175C
ARR. MOTOR INDUSTRIAL
3 x 6.2 x 14



P2176C
ARR. MINITRACTOR MODELO NUEVO
6.3 x 9.5 x 12



P2229C
PORTAESCOBILLAS ARRANQUE
TIPO MITSUBA



P2260C
ARR. MOTOR FUERA BORDA COMPLETO
6 x 9 x 12

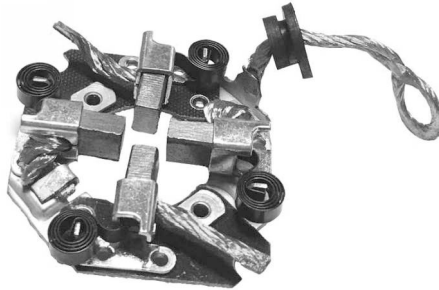

P2449C
PORTAESCOBILLAS ARRANQUE TIPO EFFA

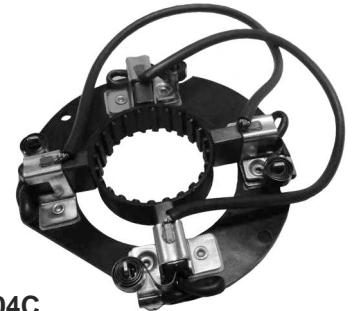

P2504C
ARR. EQUIPO THERMO KING
8.9 x 20 x 26

REPARACION DE ARRANQUE



P4080
GATILLOS ARRANQUE TIPO GAREF - DELCO REMY



P4085
GATILLOS DINAMO IKA TIPO INDIEL



P4107
1JUEGO PARA REPARAR TAPA ARRANQUE

REPARACION PORTA ESCOBILLAS ARR. INDIEL M100 FORD TAUNUS, F100, FIAT, TORINO, ETC

P4117 PORTAESCOBILLAS ARRANQUE TIPO INDIEL
P4117B PORTAESCOBILLAS ARRANQUE TIPO INDIEL

P4117BF PORTAESCOBILLAS ARRANQUE TIPO INDIEL

P4117BFI PORTAESCOBILLAS ARRANQUE TIPO INDIEL

P4117BT PORTAESCOBILLAS ARRANQUE TIPO INDIEL

P4117C PORTAESCOBILLAS ARRANQUE TIPO INDIEL



P4121
CASILLEROS PORTAESCOBILLAS ARRANQUE TIPO INDIEL - M. MARELLI

P4121C
CASILLEROS PORTAESCOBILLAS ARRANQUE TIPO INDIEL - M. MARELLI

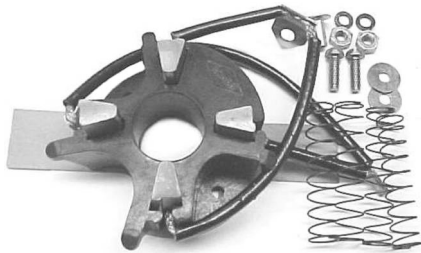

P4122C PORTAESCOBILLAS ARRANQUE TIPO INDIEL
P4122 PORTAESCOBILLAS ARRANQUE TIPO INDIEL





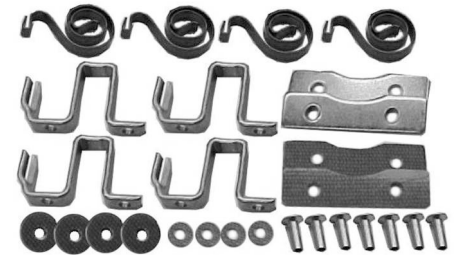





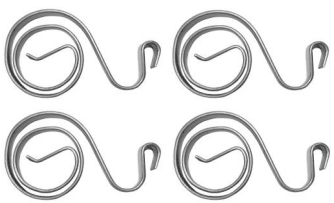

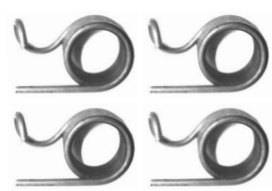

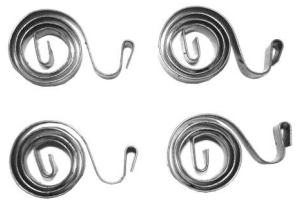

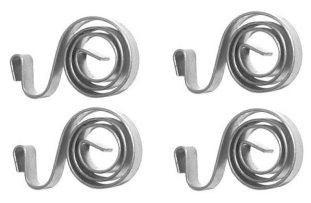

P4123
CASILLEROS PORTAESCOBILLAS ARRANQUE TIPO INDIEL - M. MARELLI

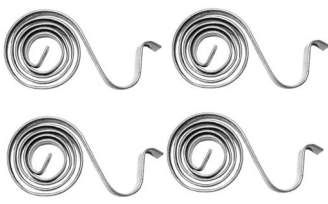
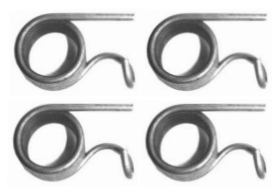
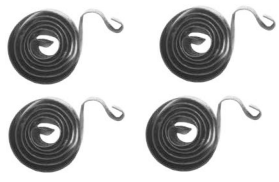
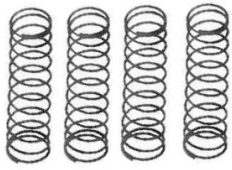

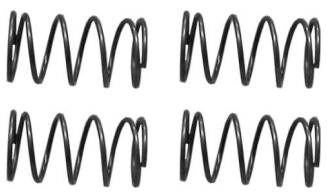
P4124
JUEGO PARA REPARAR TAPA ARRANQUE

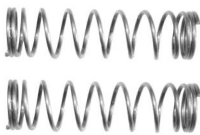
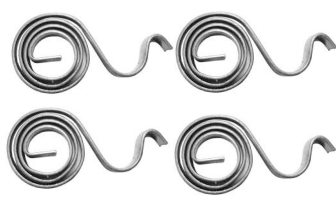

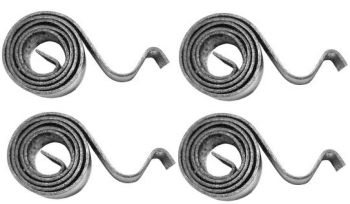









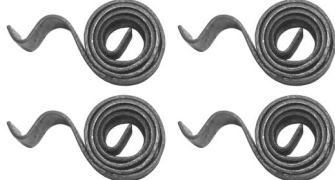

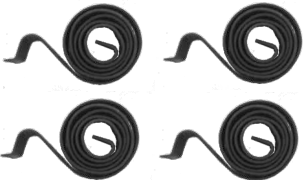



RESORTES

 <p>R1001 PORTAESCOBILLAS ARRANQUE TIPO IKA, FORD</p>	 <p>R1003 PORTAESCOBILLAS ARRANQUE BNG TIPO BOSCH</p>	 <p>R1005 PORTAESCOBILLAS TIPO INDIEL AN 115</p>	 <p>R1006 PORTAESCOBILLAS ARRANQUE FIAT 600/1100</p>
 <p>R1008 PORTAESCOBILLAS ARRANQUE FIAT 128 TIPO GAREF</p>	 <p>R1009 PORTAESCOBILLAS ARRANQUE TIPO SIAM</p>	 <p>R1010 PORTAESCOBILLAS ARRANQUE RENAUL, PEUGEOT</p>	 <p>R1013 PORTAESCOBILLAS ARRANQUE FIAT 1500/1600</p>
 <p>R1014 PORTAESCOBILLAS ARRANQUE PEUGEOT ELECTROMETALICA</p>	 <p>R1018 PORTAESCOBILLAS ARRANQUE TIPO TAMATEL</p>	 <p>R1020 PORTAESCOBILLAS ARRANQUE RASTROJERO TIPO INDIEL</p>	 <p>R1022 PORTAESCOBILLAS ARRANQUE RASTROJERO TIPO BOSCH, EJD</p>
 <p>R1023 PORTAESCOBILLAS ARRANQUE TIPO DELCO REMY</p>	 <p>R1024 PORTAESCOBILLAS ARRANQUE M.BENZ, TIPO BOSCH BRASIL</p>	 <p>R1025 PORTAESCOBILLAS ARRANQUE INDENOR TIPO INDIEL</p>	 <p>R1026 PORTAESCOBILLAS ARRANQUE TIPO BOSCH/BPD</p>
 <p>R1027 PORTAESCOBILLAS ARRANQUE FRONTAL TIPO INDIEL</p>	 <p>R1028 PORTAESCOBILLAS ARRANQUE TIPO BOSCH/FKB</p>	 <p>R1029 PORTAESCOBILLAS ARRANQUE TIPO BOSCH (ALEMAN)</p>	 <p>R1030 PORTAESCOBILLAS ARRANQUE TIPO VALEO</p>
 <p>R1031 PORTAESCOBILLAS TIPO PARIS RHONE</p>	 <p>R1032 PORTAESCOBILLAS ARRANQUE TIPO BOSCH, FIAT, RENAULT, ETC.</p>	 <p>R1033 PORTAESCOBILLAS ARRANQUE DUCATO TIPO M. MARELLI</p>	 <p>R1034 PORTAESCOBILLAS ARRANQUE TIPO VALEO (FLEJE)</p>

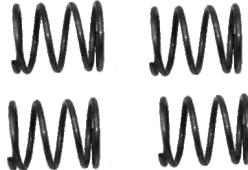

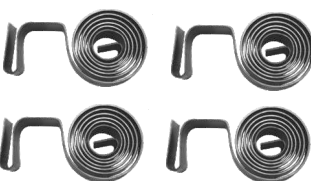











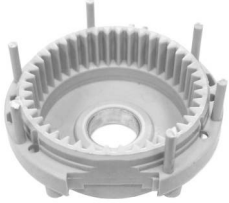

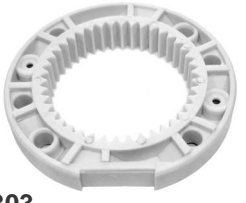

RESORTES

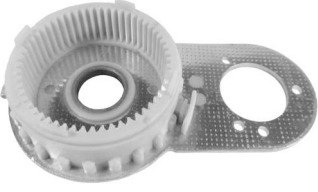
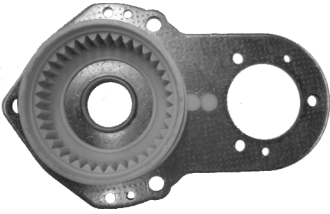
<p>R1035 PORTAESCOBILLAS ARRANQUE M. BENZ SUPER TORQUE</p>	<p>R1036 PORTAESCOBILLAS ARRANQUE TIPO BOSCH</p>	<p>R1037 PORTAESCOBILLAS ARRANQUE TIPO HITACHI</p>	<p>R1037R PORTAESCOBILLAS ARRANQUE TIPO HITACHI (CHICO)</p>
<p>R1038 PORTAESCOBILLAS ARRANQUE POLARA</p>	<p>R1039 PORTAESCOBILLAS ARRANQUE TOYOTA)</p>	<p>R1040 APORTAESCOBILLAS ARRANQUE TIPO LADA</p>	<p>R1041 PORTAESCOBILLAS ARRANQUE TIPO AUTOLITE</p>
<p>R1042 PORTAESCOBILLAS ARRANQUE TIPO WAPSA, GOL, SENDA, ETC.</p>	<p>R1043 PORTAESCOBILLAS ARRANQUE TIPO INDIEL M93R FORD MOTOR MWM</p>	<p>R1044 PORTAESCOBILLAS ARRANQUE TIPO BOSCH FIAT DUNA 1.7</p>	<p>R1045 PORTAESCOBILLAS TIPO BOSCH PEUGEOT, RENAUT, ETC.</p>
<p>R1046 PORTAESCOBILLAS ARRANQUE TIPO M. MARELLI / VALEO</p>	<p>R1047 PORTAESCOBILLAS ARRANQUE TIPO M. MARELLI, TIPO INDIEL / VALEO</p>	<p>R1048 PORTAESCOBILLAS ARRANQUE TIPO MOTORCRAFT FLEJE GRANDE</p>	<p>R1049 PORTAESCOBILLAS ARRANQUE TIPO MOTORCRAFT FLEJE CHICO</p>
<p>R1050 PORTAESCOBILLAS ARRANQUE TIPO BOSCH M. BENZ</p>	<p>R1051 PORTAESCOBILLAS ARRANQUE PEUGEOT 405</p>	<p>R1052 PORTAESCOBILLAS TIPO M OTORCRAFT (RECTANGULAR)</p>	<p>R1053 PORTAESCOBILLAS ARRANQUE TIPO MITSUBSHI PEUGEOT</p>
<p>R1054 PORTAESCOBILLAS ARRANQUE TIPO TAMATEL REFORMA DIPRA</p>	<p>R1055 PORTAESCOBILLAS ARRANQUE TIPO BOSCH (MEDIANO)</p>	<p>R1056 APORTAESCOBILLAS ARRANQUE TIPO INDIEL/LUCAS</p>	<p>R1057 PORTAESCOBILLAS ARRANQUE IMPORTADO (GRANDE)</p>

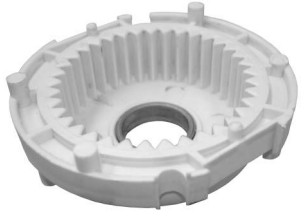
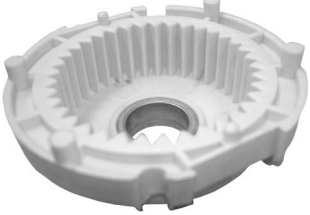
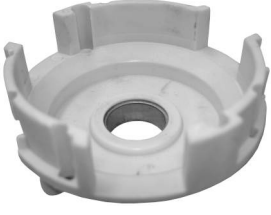
RESORTES

 <p>R1058 PORTAESCOBILLAS ARRANQUE TIPO NIPPONNIPPONDENSO</p>	 <p>R1059 PORTAESCOBILLAS ARRANQUE TIPO DELCO REMY 37/42MT</p>	 <p>R1060 PORTAESCOBILLAS TIPO DELCO REMY 28MT M. BENZ, FIAT., ETC.</p>	 <p>R1062 PORTAESCOBILLAS BOMBA COMBUSTIBLE KANGOO</p>
 <p>R1063 PORTAESCOBILLAS ARRANQUE TIPO TIPO INDIEL M100R, VW, M. BENZ, CUMMINS, ETC.</p>	 <p>R1064 PORTAESCOBILLAS ARRANQUE TIPO ISUZU</p>	 <p>R1065 PORTAESCOBILLAS ARRANQUE TIPO TOYOTA 28MT</p>	 <p>R1066 PORTAESCOBILLAS ARRANQUE TIPO TOYOTA JAPONES, M. BENZ</p>
 <p>R1067 PORTAESCOBILLAS ARRANQUE PALIO TIPO M. MARELLI</p>	 <p>R1068 PORTAESCOBILLAS DIRECCION RENAULT CLIO</p>	 <p>R1069 PORTAESCOBILLAS ARRANQUE TIPO BOSCH 6X15MM. (COMPRESION)</p>	 <p>R1070 PORTAESCOBILLAS ARRANQUE CHEVROLET CORSA TIPO DELCO REMY</p>
 <p>R1071 PORTAESCOBILLAS ARRANQUE BLAZER TIPO DELCO REMY</p>	 <p>R1072 PORTAESCOBILLAS ARRANQUE TIPO HITACHI</p>	 <p>R1073 PORTAESCOBILLAS ARRANQUE FIAT 147 TIPO M. MARELLI</p>	 <p>R1074 PORTAESCOBILLAS ARRANQUE ISUZU DIESEL HITACHI</p>
 <p>R1075 PORTAESCOBILLAS ARRANQUE SERVICIO PESADO</p>	 <p>R1076 PORTAESCOBILLAS ARRANQUE ASTRA</p>	 <p>R1077 PORTAESCOBILLAS ARRANQUE TIPO TOYOTA</p>	 <p>R1078 PORTAESCOBILLAS ARRANQUE TIPO WAPSA</p>
 <p>T8196 TORNILLOS Y RESORTES ARRANQUE TIPO INDIEL AN 115</p>			

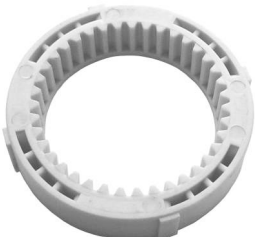
PLANETARIOS Y REDUCTORES

 <p>P1200 TAPA PLANETARIO BOSCH RENAULT, PEUGEOT</p>	 <p>P1201 TAPA PLANETARIO INDIEL M93R, M100R</p>	 <p>P1202 MOTORCRAFT, ESCORT, FIESTA,KA</p>	 <p>P1203 TAPA DE PLANETARIO ARRANQUE TIPO MOTORCRAFT</p>
 <p>P1204 TAPA DE PLANETARIO ARRANQUE TIPO MOTORCRAFT (PLANA)</p>	 <p>P1301 BOSCH FIAT DUNA DIESEL 1,7 (9005821303) Z42</p>	 <p>P1302 BOSCH CHICO, VW, RENAULT, FORD (1 006 200 110/123/128) Z37</p>	 <p>P1303 BOSCH ESCORT, A. ROMEO PEUGEOT, VW, CITROEN, TRANSIT,-DUCATO Z42</p>
 <p>P1304 MOTORCRAFT, ESCORT, FIESTA MOTOR ZETEC Z45</p>	 <p>P1305 BOSCH, POLO, ESCORT, GOLF, ROVER, ALFA ROMEO, AUDI (1 005 821 307) Z37</p>	 <p>P1306 MARELLI FIAT DUCATO Z39</p>	 <p>P1307 VALEO, RENAULT 19, TRAFIC, EXPRESS (FINO) Z59</p>
 <p>P1308 VALEO, PEUGEOT 306-405 DIESEL RENAULT 19 -CLIO DIESEL Z56</p>	 <p>P1309 VALEO, PEUGEOT 205 - 306 - 405- BOXER Z37 FINOS</p>	 <p>P1310 VALEO, PEUGEOT Z41 GRUESOS</p>	 <p>P1311 MOTORCRAFT, TRANSIT BUJE ALTURA 6mm - eje ø19 Z37</p>
 <p>P1312 MOTORCRAFT, TRANSIT BUJE ALTURA 10mm - eje ø17,5 Z37</p>	 <p>P1313 BOSCH, CLIO DIESEL, RENAULT EXPRESS</p>	 <p>P1314 BOSCH, KANGOO - EXPRESS (1 006 200 059)</p>	 <p>P1315 BOSCH, VW GOLF, POLO TD (9005821333)</p>
 <p>P1316 CORSA, DAEWOO, ESPERO Z50</p>	 <p>P1317 MARELLI, FIAT DUCATO Z39</p>	 <p>P1318 BOSCH MEXICANO, NISSAN (2 337 1F4 029) Z36</p>	 <p>P1319 BOSCH, LAGUNA (1 006 200 161) Z36</p>

PLANETARIOS Y REDUCTORES



P1320
M. BENZ C180 - E230, DAKOTA
(1 006 200 059)

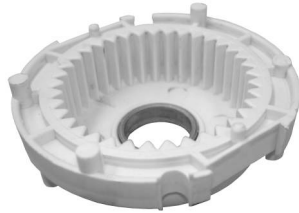

P1321
MOTORCRAFT, TRANSIT
BUJE ALTURA 6mm-eje ø17,5 Z37

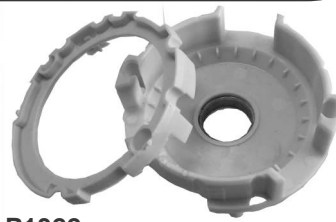

P1322
BOSCH, CITROEN, FIAT, TOYOTA,
NISSAN, PEUGEOT, VW

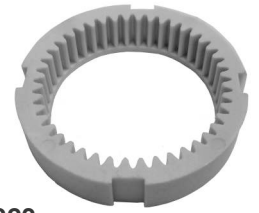

P1323
MARELLI, DUCATO,
PALIO, SIENA Z44

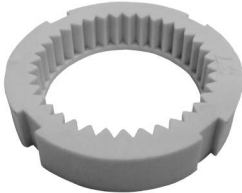

P1324
MARELLI, PALIO SIENA Z37

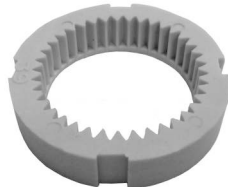

P1325
MARELLI, PALIO SIENA Z39



P1326
VALEO, RENAULT MASTER Z59



P1328
VALEO, GOL, TRANSPORTER Z56



P1329
BOSCH, FIAT DUCATO,
FORD, MOTOR MWM CUMMINS



P1330
DELCO REMY, DAEWU,
TICO Z43



P1331
VALEO, VW, AUDI A3, VENTO Z56



P1332
BOSCH, FIAT, CHEVROLET,
M.BENZ, RENAULT, DODGE,
VOLKSWAGEN



P1353
MITSUBISHI, CHEVROLET,
DODGE, FORD, CHRYSLER Z43



P1354
MITSUBISHI, AUTOELEVADOR
RENAULT Z42



P1355
BOSCH, M. BENZ, BMW, CHEVROLET, GM, OPEL,
VW, AUDI, FIAT, FORD, RENAULT(1 006 200 145)



P1362
(1 006 200 104)



P1363
DELCO REMY, PEUGEOT 206 Z50



P1364
DELCO REMY, ASTRA, BLAZER,
VECTRA Z50



P1365
DELCO REMY, BLAZER, CLARK,
MOTOR VORTEC Z48



P1366
MITSUBISHI, CHEVROLET, CLARK
YALE (M135X01571) Z43



P1367
MOTORCRAFT, FORD KA Z59



P1368
INDIEL M93R



P1370
MITSUBISHI, FORD, CHEVROLET,
MAZDA Z42



P1371
CHEVROLET, BLAZER
MOTOR VORTEC Z43

PLANETARIOS Y REDUCTORES



P1372
MITSUBISHI, CHEVROLET,
S-10 MOTOR MWM 2.8 Z44



P1375
CHEVROLET, GM BLAZER
MOTOR VORTEC V6 4.3 Z50



P1376
PLANETARIO DE ARRANQUE
TIPO VALEO



P1377
PLANETARIO DE ARRANQUE
TIPO VALEO



P1378
PLANETARIO DE ARRANQUE
TIPO BOSCH



P1383
INDIEL M100R

P1401

BOSCH, ASTRA, VECTRA,
ALFA ROMEO, OPEL (largo 94,5)
(1 006 200 110)

P1402

BOSCH, ESCORT, VW POINTER,
(F000 AL1 015)(largo 118,5)

P1404

BOSCH VOLKSWAGEN -
(F000 AL1 019) (largo 99 mm.)

P1405

BOSCH, FIAT TEMPRA (F000 AL1 017) (largo 100 mm.)

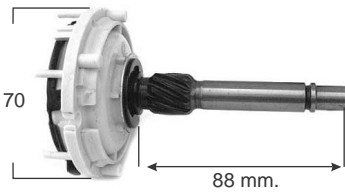

P1403
AUDI, PEUGEOT, FIAT, JEEP,
ROVER, CHEVROLET

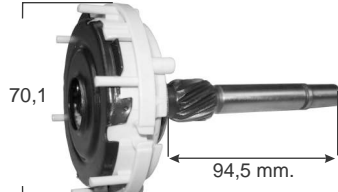

P1406
BOSCH, GOLF (F000 AL0 128 -
1 006 200 128 F 000 AL0 128)

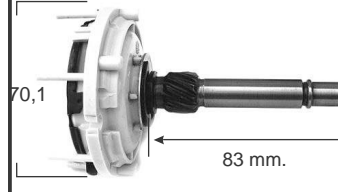

P1407
BOSCH, NISSAN MEXICANO,
OPEL, CHEVROLET (23371-F4029)

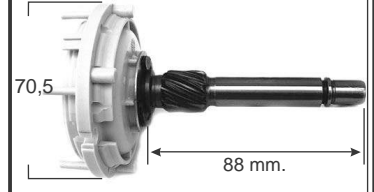

P1408
BOSCH, RENAULT LAGUNA
(1 006 200 161)

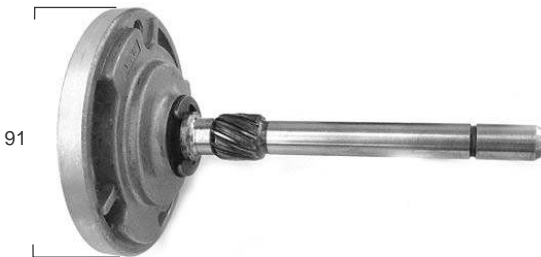

P1409

INDIEL SPRINTER, RANGER, VW,
M.BENZ, MWM (largo 100 mm)
352.58.669

P1412

INDIEL M. BENZ
(largo 122 mm) 352.59.959

P1419

INDIEL GIRO IZQ, VW SUDAFRICA
(largo 138,2 mm) 352.59.859

P1421

INDIEL PEUGEOT, FORD
(largo 101 mm) 352.59.952

P1422

INDIEL DEUTZ, FORD, J. DEERE, CUMMINS
PERK.- etc. (largo 122) 352.59.465

P1443

INDIEL CUMMINS, VW, FORD
(largo 128,8 mm) 352.59.915

P1449

INDIEL M.BENZ, CUMMINS, FORD, M93R
(largo 122,5) 352.58.853



P1410
MOTORCRAFT, ESCORT, FIESTA,
KA, MOTOR ZETEC



P1411
BOSCH FIAT. IVECO: DAILY,
DEUTZ



P1413
BOSCH DUCATO 2.8 FORD,
DAILY, PEUGEOT, JUMPER

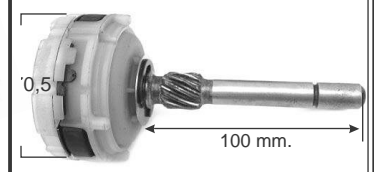

P1414
BOSCH, M. BENZ. CHEVROLET,
BMW, OPEL, RENAULT, FORD,
FIAT, AUD, SEAT. (1 006 200 104)



P1415
BOSCH 12v FORD F-250/F-350/
F-4000 4cc CUMMINS 4BTAA



P1416
BOSCH, CITROEN, DUCATO,
STRADA, PUNTO, SPRINTER

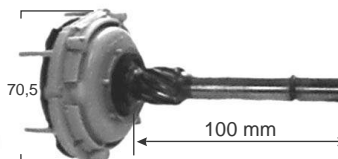

P1417
BOSCH, ALFA, AUDI, FIAT, JEEP,
CHEVROLET, VW.
(1 005 821 307)



P1418
BOSCH, TOYOTA HILUX/SW4
D4D 2.5/2.8/3.0

PLANETARIOS Y REDUCTORES

 <p>P1420 BOSCH 12v. AUDI A2/A3, FORD, SEAT, VW</p>	 <p>P1423 BOSCH, ALFA ROMEO, CITROEN, PEUGEOT, RENAULT, VW</p>	 <p>P1424 BOSCH, SEAT, VW POLO 1.7/1.9D SD</p>	 <p>P1425 BOSCH 12v. SEAT CORDOBA, VW GOLF 1.9 TDI (97-01)</p>
 <p>P1426 VW GOLF 1.9 TDI (97-01)</p>	 <p>P1427 BOSCH, PORSCHE, CAYENNE 2002</p>	 <p>P1428 BOSCH, VOLKSWAGEN GOL, SAVEIRO</p>	 <p>P1429 BOSCH, JUMPER DUCATO, PEUGEOT, BOXER 2.8</p>
 <p>P1430 BOSCH, TOYOTA HILUX D4D, SW4 D4D, COROLLA, RAV4, LANDCRUISER</p>	 <p>P1431 BOSCH, FIAT DUCATO, SPRINTER, DAILY, DAKOTA, F-1000 BLAZER</p>	 <p>P1432 BOSCH, FIAT DUCATO2.8, FORD F-250, DAILY, PEUGEOT</p>	 <p>P1441 INDIEL M100R, J. DEERE, MOT.CUMMINS, MWM, LARGO 81,70 mm</p>
 <p>P1442 INDIEL M100R, J. DEERE, MOT.CUMMINS, MWM, LARGO 120,30 mm</p>	 <p>P1445 BOSCH, M. BENZ, BMW (1 006 200 145)</p>	 <p>P1450 DELCO REMY, CHEVROLET</p>	 <p>P1451 MITSUBISHI, MAZDA, CHEVROLET, NISSAN</p>
 <p>P1452 MITSUBISHI, CHEVROLET S-10 MOTOR MWM, MITSUBISHI L-200</p>	 <p>P1453 DELCO REMY 29MT, FORD, M. BENZ, VOLVO, VOLKSWAGEN</p>	 <p>P1454 MITSUBISHI, PAJERO, MONTERO</p>	 <p>P1455 MITSUBISHI, AUTOELEVADOR CLARK</p>
 <p>P1456 MITSUBISHI, AUTOELEVADOR HYSTER, RENAULT</p>	 <p>P1458 BOSCH, CHEVROLET, VECTRA, ASTRA, ZAFIRA 2.0 16v.- (1 006 200 058)</p>	 <p>P1459 BOSCH, M. BENZ, CHRYSLER (1 006 200 059)</p>	 <p>P1460 MOTORCRAFT, FORD, RANGER, ECO SPORT - 4 ENGRANAJES</p>

PLANETARIOS Y REDUCTORES

 <p>P1461 MOTORCRAFT, FORD RANGER EXPLORER 4.0 - 3 ENGRA. BUJE 10mm.</p>	 <p>P1462 MOTORCRAFT, FORD F100-F4000 3 ENGRANAJES</p>	 <p>P1468 DELCO REMY CHEVROLET</p>	 <p>P1469 DELCO REMY, 28 MT</p>
 <p>P1470 DELCO REMY, 28 MT</p>	 <p>P1471 DELCO REMY, CHEVROLET OMEGA DEL 95 AL 98</p>	 <p>P1472 BOSCH, M.BENZ, MB180D (MOTOR 616) SSANGYONG MUSSO 2,9</p>	 <p>P1473 BOSCH, CHEVROLET ASTRA, BLAZER, S10, VECTRA (1.8/2.0/2.2) 8 VALVULAS</p>
 <p>P1474 BOSCH, VW TRANSPORTER 2,4 DIESEL</p>	 <p>P1475 BOSCH, TOYOTA COROLLA 1,8l 16v</p>	 <p>P1476 DELCO 38MT, FORD CARGO MOTOR CUMMINS, VW 17-220</p>	 <p>P1477 DELCO REMY 29 MT, FORD, MB, VOLVO, VW</p>
 <p>P1478 VALEO HYUNDAI, KIA, M. BENZ SPRINTER</p>	 <p>P1479 VALEO CHEVROLET, RENAULT, PEUGEOT,</p>	 <p>P1480 VALEO CHEVROLET, RENAULT, PEUGEOT, CITROEN, SATURN Z59. D6RA65, D6RA165</p>	 <p>P1482 VALEO, AUDI A3, CITROEN X-SARA, SUZUKI GRAND VITARA</p>
 <p>P1483 VALEO, CLIO EXPRESS, MEGANE EXPRESS, R19, LAGUNA, HYUNDAI, MITSUBISHI L200</p>	 <p>P1490 DELCO REMY, CHEVROLET BLAZER</p>	 <p>P1491 DELCO CHEVROLET, CLARK (10475626)</p>	 <p>P1492 PLANETARIO DE ARRANQUE TIPO VALEO</p>
 <p>P1493 PLANETARIO DE ARRANQUE TIPO VALEO</p>	 <p>P1500 MOTORCRAFT (C/ 3 ENGRANAJES)</p>	 <p>P1501 FIAT 1.7 DIESEL</p>	 <p>P1502 BOSCH, CITROEN, FIAT, M.BENZ, NISSAN, PEUGEOT, VW. Z38</p>

PLANETARIOS Y REDUCTORES



P1503
BOSCH, CITROEN, FIAT,
PEUGEOT, Z38



P1504
MOTORCRAFT, ESCORT, FIESTA,
KA, MOTOR ZETEC



P1505
BOSCH, TOYOTA HILLUX SW4
D4D, COROLA, RAV,
LAND CRUISER. Z37



P1506
BOSCH, SEAT, VW GOLF 1.9. Z42



P1507
BOSCH, FIAT DUCATO, FORD
MOTOR MWM CUMMINS, Z40



P1508
BOSCH, VOLKSWAGEN Z38



P1511
BOSCH C/ENGRANAJE FORD
(1 006 200 110/123/128 * F 000
AL1 015/017/019)



P1512
MOTORCRAFT (C/4 ENGRANAJES)



P1518
BOSCH, NISSAN MEXICANO
(2 337 1F4 029) (C/ ENGRANAJES)

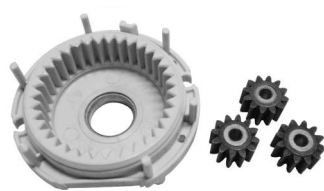

P1519
BOSCH, RENAULT LAGUNA
(1 006 200 161) C/ ENGRANAJES



P1521
MOTORCRAFT, BUJE Ø17.5
(C/ 3 ENGRANAJES)

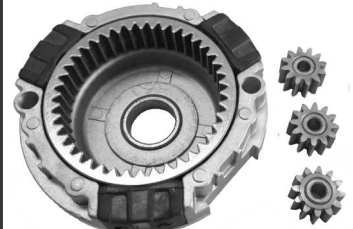

P1532
BOSCH, BLAZER, DUCATO,
TRANSPORTER, JUMPER. Z42



P1547
INDIEL M93R, SPRINTER, AGRALE
VW, DUCATO Mot. MAXION
CUMMINS(K21147) (1 126 600 975)



P1568
INDIEL M93R



P1580
BOSCH, FIAT, ALFA, VW, JEEP,
AUDI, CHRYSLER
(1 005 821 307) C/ ENGRANAJES

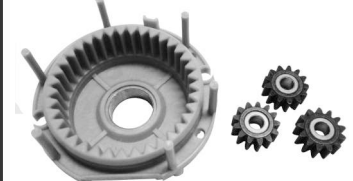

P1581
BOSCH, ALFA, FIAT, VW, JEEP,
AUD, CHRYSLER - etc.
(1 005 821 307) C/ ENGRANAJES



P1582
INDIEL, HITACHI M74R



P1583
INDIEL M100R
(CORONA Y GOMAS)



P1584
INDIEL M100R (COMPLETO)



P1586
BOSCH, M. BENZ, CHRYSLER
(1 006 200 059) C/ ENGRANAJES



P1587
BOSCH, M.BENZ, BMW, FIAT,FORD
VOLVO, OPEL, CHEVROLET,
RENAULT, (1 006 200 104)



P1588
DELCO REMY, CHEVROLET
C/ ENGRANAJES









P1589
DELCO REMY, VECTRA, ASTRA,
(F 000 LD1 371) C/ ENGRANAJES

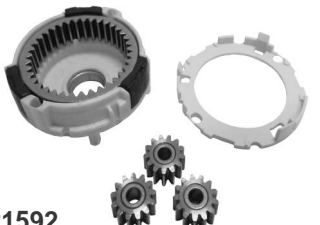















P1590
BOSCH, M. BENZ, BMW
(1 006 200 145) C/ ENGRANAJES







PLANETARIOS Y REDUCTORES

 <p>P1591 DELCO REMY, CHEVROLET, CLARK C/ ENGRANAJES</p>	 <p>P1592 BOSCH, OPEL, ASTRA, VECTRA C/ ENGRANAJES</p>	 <p>P1593 CHEVROLET S10, BLAZER MOTOR VORTEC C/ ENGRANAJES</p>	 <p>P1594 MITSUBISHI L200, CHEVROLET S10 MOTOR MWM C/ ENGRANAJES</p>
 <p>P1595 MITSUBISHI, AUTOELEVADOR HYSTER, RENAULT C/ENGRANAJES</p>	 <p>P1596 MAZDA MIATA C/ ENGRANAJES</p>	 <p>P1597 MITSUBISHI, CHEVROLET, CHRYSLER, DODGE, HYUNDAI, etc. C/ ENGRANAJES</p>	 <p>P1598 CHEVROLET, OMEGA SUPREMA, CLARK C/ ENGRANAJES</p>

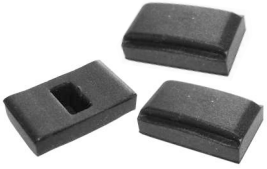
ENGRANAJES DE PLANETARIOS

 <p>E8001 JGO. DE 3 ENGRANAJES T. BOSCH Z12</p>	 <p>E8002 JGO. DE 3 ENGRANAJES T. MOTORCRAF Z13</p>	 <p>E8003 JGO. DE 3 ENGRANAJES TIPO VALEO Z22</p>	 <p>E8004 JGO. DE 4 ENGRANAJES T. MOTORCRAF Z13</p>	 <p>E8005 JGO. DE 3 ENGRANAJES T. MOTORCRAFT MOTOR ZETEC Z18</p>	 <p>E8006 JGO. DE 3 ENGRANAJES PLANETARIO T. INDIEL CUMMINS, MWM Z12</p>	 <p>E8007 JGO. DE 3 ENGRANAJES PLANETARIO TIPO HITACHI / INDIEL Z14</p>
 <p>E8008 JGO. DE 3 ENGRANAJES PLANETARIO T. DELCO REMY Z17</p>	 <p>E8009 JGO. DE 3 ENGRANAJES PLANETARIO T. DELCO REMY</p>	 <p>E8010 JGO. DE 3 ENGRANAJES ARRANQUE Z16</p>	 <p>E8011 JGO. DE 3 ENGRANAJES ARRANQUE T. VALEO PEUGEOT Z19</p>	 <p>E8012 JGO. DE 3 ENGRANAJES ARRANQUE T. INDIEL M100R Z18</p>	 <p>E8013 JGO. DE 4 ENGRANAJES ARRANQUE T. INDIEL M101 Z16</p>	 <p>E8014 JGO. DE 3 ENGRANAJES T. VALEO Z19</p>
 <p>E8015 JGO. DE 3 ENGRANAJES T. VALEO (ARRANQUE CHINO) Z15</p>						

GOMAS DE PLANETARIOS

 <p>G3501 JGO. PLANETARIO ARRANQUE TIPO BOSCH CHICO 12X20MM. (Cant. 3)</p>	 <p>G3502 JGO. PLANETARIO ARRANQUE TIPO INDIEL 12X25MM. (Cant. 3)</p>	 <p>G3503 JGO. PLANETARIO ARRANQUE TIPO BOSCH MEDIANO 15X20MM. (Cant. 3)</p>	 <p>G3504 JGO. PLANETARIO TIPO BOSCH GRANDE 15X25MM. (Cant. 3)</p>
 <p>G3505 ANTIVIBRADORA PLANETARIO ARRANQUE TIPO INDIEL M74R (Cant. 1)</p>	 <p>G3506 JGO. PLANETARIO ARRANQUE TIPO INDIEL M100R (Cant. 1)</p>		





















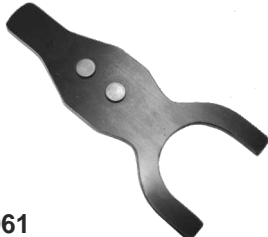

HORQUILLAS DE MANDO

<p>H1001 ARRANQUE RENAULT 6/12/18</p>	<p>H1002 ARRANQUE TIPO INDIEL RENAULT 12TS, TORINO</p>	<p>H1003 ARRANQUE DODGE 1500 TIPO TRIA PLASTICA</p>	<p>H1004 ARRANQUE CHEVROLET 400 TIPO INDIEL</p>
<p>H1004/1 AARRANQUE CHEVROLET 400, FALCON</p>	<p>H1005 ARRANQUE INDENOR IME</p>	<p>H1006 AARRANQUE FIAT 600 TIPO GAREF</p>	<p>H1007 ARRANQUE FIAT 1500 TIPO GAREF</p>
<p>H1008 ARRANQUE FIAT 128</p>	<p>H1009 ARRANQUE FIAT 125</p>	<p>H1010 ARRANQUE FRONTAL FORD TIPO INDIEL</p>	<p>H1011 ARRANQUE INDENOR TIPO ROHER</p>
<p>H1012 ARRANQUE PEUGEOT 404 TIPO GAREF</p>	<p>H1013 ARRANQUE TORINO, RENAULT TS</p>	<p>H1014 ARRANQUE RASTROJERO EJD TIPO BOSCH</p>	<p>H1015 ARRANQUE RASTROJERO TIPO BOSCH SD</p>
<p>H1016 ARRANQUE RASTROJERO TIPO BOSCH 2° SERIE</p>	<p>H1017 ARRANQUE TIPO TIPO BOSCH JF BRASIL</p>	<p>H1018 ARRANQUE TIPO NASHVILLE</p>	<p>H1018N ARRANQUE TIPO NASHVILLE MODELO NUEVO</p>
<p>H1019 ARRANQUE ARRANQUE TIPO INDIEL AN 115</p>	<p>H1019MB ARRANQUE ARRANQUE AN 115 M. BENZ</p>	<p>H1020 ARRANQUE FRONTAL TIPO INDIEL CHICO M/VIEJO</p>	<p>H1021 ARRANQUE FRONTAL TIPO INDIEL CHICO M/NUEVO</p>

HORQUILLAS DE MANDO

<p>H1022 ARRANQUE RENAULT TIPO VALEO, RENAULT 19</p>	<p>H1023 ARRANQUE ARRANQUE TIPO PARIS RHONE</p>	<p>H1024 ARRANQUE DODGE 1500 TIPO TRIA (CHAPA)</p>	<p>H1025 ARRANQUE TIPO VALEO PEUGEOT 405</p>
<p>H1026 ARRANQUE PEUGEOT TIPO TAMATEL</p>	<p>H1030 ARRANQUE TIPO WAPSA SENDA, ETC.</p>	<p>H1031 ARRANQUE TIPO BOSCH FIAT 147, RENAULT, PEUGEOT, ETC.</p>	<p>H1032 ARRANQUE TIPO HITACHI INDIEL</p>
<p>H1033 ARRANQUE CHEVROLET TIPO DELCO REMY</p>	<p>H1034 ARRANQUE TIPO M. MARELLI FIAT PALIO/SIENA</p>	<p>H1035 ARRANQUE TIPO BOSCH DUNA, RENAULT 9/11, SENDA, ETC.</p>	<p>H1036 ARRANQUE TIPO ARGELITE</p>
<p>H1037 ARRANQUE TIPO TIPO INDIEL M93R Y M100R</p>	<p>H1038 ARRANQUE TIPO BOSCH</p>	<p>H1039 ARRANQUE RENAULT KANGOO</p>	<p>H1040 ARRANQUE TIPO NIPPONIPPONDENSO CHICA</p>
<p>H1041 ARRANQUE TIPO MITSUBISHI PEUGEOT 405TD</p>	<p>H1042 ARRANQUE TIPO HITACHI CORSA DIESEL</p>	<p>H1043 ARRANQUE TIPO MOTORCRAFT, FORD KA / ESCORD, ETC.</p>	<p>H1044 ARRANQUE TIPO ARGELITE RENAULT 9/19</p>
<p>H1045 ARRANQUE TIPO VALEOT TRAFIC</p>	<p>H1046 ARRANQUE TIPO NIPONDENSSO, TOYOTA, ISUZU</p>	<p>H1047 ARRANQUE TIPO NIPONDENSSO</p>	<p>H1048 ARRANQUE TIPO BOSCH DUCATO</p>

HORQUILLAS DE MANDO

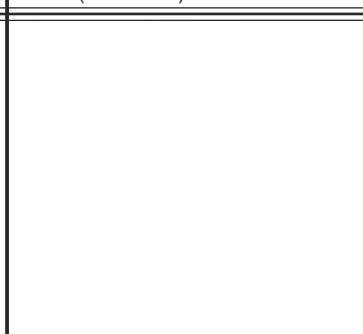
 <p>H1049 ARRANQUE TIPO DELCO REMY PESADA</p>	 <p>H1050 ARRANQUE TIPO M. MARELLI DUCATO</p>	 <p>H1051 ARRANQUE TIPO WAPSA MOTOR PERKINS</p>	 <p>H1052 ARRANQUE TIPO BOSCH FORD 1000</p>
 <p>H1053 ARRANQUE TIPO DELCO REMY 28MT M. BENZ 180/912</p>	 <p>H1054 ARRANQUE TIPO DELCO REMY 28MT, M. BENZ 912/1215/1214</p>	 <p>H1055 ARRANQUE AUTOELEVADOR TIPO NIPONNIPPONDENSO</p>	 <p>H1056 ARRANQUE TIPO HITACHI CORSA DIESEL</p>
 <p>H1057 ARRANQUE TIPO M. MARELLI FIAT UNO</p>	 <p>H1058 ARRANQUE TIPO M. MARELLI FIAT</p>	 <p>H1059 ARRANQUE TIPO BOSCH VARIOS (1.001.933.113)</p>	 <p>H1060 ARRANQUE TIPO BOSCH VARIOS</p>
 <p>H1061 ARRANQUE TIPO TRIA POLARA (CHAPA)</p>	 <p>H1062 ARRANQUE DODGE POLARA TIPO TRIA (CHAPA)</p>	 <p>H1063 ARRANQUE TIPO TIPO BOSCH RENAULT SANDERO / KANGOO / LOGAN</p>	 <p>H1064 ARRANQUE TIPO MITSUBISHI</p>
 <p>H1065 ARRANQUE TIPO TIPO DELCO REMY PEUGEOT</p>	 <p>H1066 ARRANQUE RENAULT TIPO VALEO</p>	 <p>H1067 ARRANQUE TIPO DELCO REMY</p>	 <p>H1068 ARRANQUE TIPO DELCO REMY 29MT (10515805)</p>
			

PATINES			
P5100 HORQUILLA DE ARRANQUE RENAULT - PEUGEOT (Cant. 2)	P5103 HORQUILLA DE ARRANQUE TIPO TAMATEL (Cant. 1)	P5104 HORQUILLA ARRANQUE TIPO HITACHI (Cant. 1)	

PERNOS Y TRABAS DE HORQUILLAS

P6004 ARRANQUE TIPO BOSCH (Cant. 1)	P6019 ARRANQUE TIPO INDIEL (Cant. 1)	P6019MB ARRANQUE TIPO INDIEL (Cant. 1)	P6104 ARRANQUE TIPO INDIEL (Cant. 1)
P6105 ARRANQUE TIPO TAMATEL (Cant. 1)	P6106 ARRANQUE TIPO GAREF (Cant. 1)	P6107 ARRANQUE TIPO VALEO (Cant. 1)	P6108 ARRANQUE TIPO INDIEL (Cant. 1)
P6109 ARRANQUE TIPO GAREF (Cant. 1)	P6110 ARRANQUE TIPO INDIEL (Cant. 1)	P6111 ARRANQUE TIPO WAPSA (Cant. 1)	P6112 ARRANQUE TIPO BOSCH (Cant. 1)
P6119 ARRANQUE TIPO ROHER (Cant. 1)	P6120 ARRANQUE TIPO DELCO REMY (Cant. 1)	P6125 ARRANQUE TIPO INDIEL (Cant. 1)	P6126 ARRANQUE TIPO INDIEL (Cant. 1)
P6127 ARRANQUE TIPO BOSCH (Cant. 1)	P6128 ARRANQUE TIPO BOSCH (Cant. 1)	P6129 ARRANQUE TIPO BOSCH (Cant. 1)	P6130 ARRANQUE TIPO BOSCH (Cant. 1)

PERNOS Y TRABAS DE HORQUILLAS

P6131
ARRANQUE TIPO HITACHI
(Cant. 1)



P6132
ARRANQUE TIPO INDIEL (Cant. 1)



P6133
ARRANQUE TIPO INDIEL (Cant. 1)



P6134
ARRANQUE TIPO HITACHI - INDIEL
(Cant. 1)



P6135
ARRANQUE TIPO HITACH
(Cant. 1)



P6136
ARRANQUE TIPO MAGNETI
MARELLI (Cant. 1)



P6137
ARRANQUE TIPO HITACHI - INDIEL
(Cant. 1)



P6138
ARRANQUE TIPO ISUZU (Cant. 1)



P6150
ARRANQUE TIPO IME (Cant. 1)



P6151
ARRANQUE TIPO BOSCH (Cant. 1)



P6152
ARRANQUE TIPO BOSCH (Cant. 1)

P6153
ARRANQUE TIPO BOSCH (Cant. 1)



P6154
CARRANQUE TIPO BOSCH - TRIA
(Cant. 10)



P6575
TRABA PERNO HORQUILLA
(Cant. 10)



P6576
TRABA PERNO HORQUILLA
(Cant. 10)

FRENOS - ARANDELAS - TRABAS DE INDUCIDO

F1006
JUEGO DE FRENO DE
ARRANQUE TIPO BOSCH JF



F1014
ARRANQUE TIPO INDIEL
RENAULT, PEUGEOT, ETC.
(BAQUELITA)



F1015
FIAT 1500/1600



F1018
CONICA FRENO FIAT 1500



F1053
DOBLE PESTAÑA, FRENO
ARRANQUE TIPO INDIEL M93
(Cant. 10)



F1072
JUEGO ARRANQUE TIPO INDIEL
RENAUL, PEUGEOT, FIAT
COMPLETO



F1073
JUEGO ARRANQUE CITROEN
COMPLETO



F1074
JUEGO ARRANQUE TIPO
TAMATEL COMPLETO

FRENOS - ARANDELAS - TRABAS DE INDUCIDO

<p>F1075 JUEGO ARRANQUE TIPO INDIEL FRONTAL MEDIANO</p>	<p>F1076 JUEGO ARRANQUE TIPO INDIEL FRONTAL CHICO MODELO NUEVO</p>	<p>F1078 TORNILLOS FRENO ARRANQUE TIPO INDIEL ROSCA IZQ. (Cant. 10)</p>	<p>F1148 JUEGO ARRANQUE TIPO EJD / BOSCH BRASIL</p>
<p>F1149 ARANDELAS MICARTA ARRANQUE TIPO BOSH BRASIL FJ 20X35X1.2MM. (Cant. 10)</p>	<p>F1150 SUPLEMENTO RASTROJERO, M. BENZ TIPO BOSCH/EJD 19.5X39X1MM. (Cant. 10)</p>	<p>F1159 TOPE LADO COLECTOR RASTROJERO</p>	<p>F1249 FRENO ARRANQUE RENAULT, PEUGEOT TIPO INDIEL (Cant. 10)</p>
<p>A3080 CON TRABA LADO COLECTOR ARRANQUE TIPO BOSCH JF (Cant. 10)</p>	<p>A3081 JUEGO ARANDELAS SUPLEMENTO ARRANQUE TIPO BOSCH JF</p>	<p>S3007 SEGURO SEGUER DE BOBINA ARRANQUE TIPO TRIA (Cant. 10)</p>	<p>S3009 SEGUROS TIPO "U" ARRANQUE TIPO TRIA (Cant. 5)</p>
<p>S3010 TAPA Y TRABA DE INDUCIDO ARRANQUE TIPO BOSCH JF</p>	<p>S3011 TAPA Y TRABA INDUCIDO TIPO BOSCH CHICO</p>	<p>S3012 TAPA Y TRABA INDUCIDO TIPO BOSCH MEDIANO</p>	<p>S3079 ARANDELA DE CIERRE ARRANQUE TIPO HITACHI M74R</p>
<p>S3088 TRABA INDUCIDO ARANQUE TIPO HITACHI</p>			

ARANDELAS Y RESORTES PARA IMPULSOR



A3013
JUEGO TRABAS IMPULSOR
POLARA-DODGE 1500



A3038
JUEGO ARANDELAS PLASTICO
BENDIX FIAT 125



A3039
JUEGO ARANDELAS PLASTICO
BENDIX FIAT 128



A3061
JUEGO DE TRABAS BENDIX
FORD SIERRA



R3200
RESORTE BARRILITO IKA,
MOTOR CONTINENTAL



R3205
RESORTE BARRILITO MOTOR
TORNADO

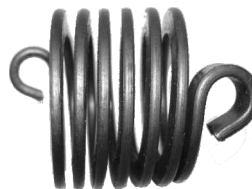

R3206
RESORTE BARRILITO FORD
CON OJALES

ESPINAS Y CHAVETAS IMPULSOR



A3086
TRABA BARRILITO IKA (Cant. 1)



C2061
CHAVETAS PARTIDAS SURTIDAS
(Cant. 100)

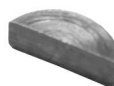

C2091
CHAVETA CAMPANA ARRANQUE
TIPO BOSCH, FKB (Cant. 1)



C2093
CHAVETA PLANA ARRANQUE
FKB LADO PIÑON (Cant. 1)



C2094
CHAVETA CAMPANA
ARRANQUE BNG (Cant. 10)



E1067
ESPINAS BENDIX TORNADO,
VALIANT (Cant. 2)



E1068
ESPINAS TUERCA TOPE
IMPULSOR INDUCIDO RENAULT
(Cant. 10)



E1070
ESPINA IMPULSOR FORD F100
(Cant. 1)

TOPE IMPULSOR



S2123
PLASTICO DE IMPULSOR
ARRANQUE TIPO INDIEL



S2125
FINO DE BENDIX ARRANQUE
TIPO GAREF



S2125G
BENDIX TIPO GAREF
EJE GRUESO























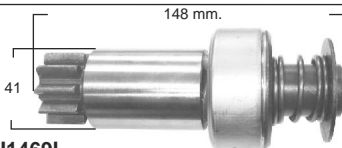

S2128
DE INDUCIDO ARRANQUE
TIPO INDIEL M93R



S2129
DE INDUCIDO ARRANQUE TIPO
INDIEL M100R

IMPULSORES PARA MOTORES DIPRA

 <p>I1027 REFORMA ARRANQUE DIPRA MOTOR CONTINENTAL AUTOELEVADO LARGO 82MM. I1027JE REFORMA ARRANQUE DIPRA JEEP, ESTANCIERA MOTOR CONTINENTAL LARGO 79MM.</p>	 <p>I1027/5 REFORMA ARRANQUE DIPRA DODGE 100/200 MOTOR VALINAT</p>	 <p>I1045 REFORMA ARRANQUE DIPRA RUSLAN, BELARUZ</p>	 <p>I1047R REFORMA ARRANQUE DIPRA AN115 Z11 REFORZADO FIAT 619, SCANIA, ETC.</p>
 <p>I1049 REFORMA ARRANQUE DIPRA CAMION 3 STAR Z11 I1059 REFORMA ARRANQUE DIPRA NISSAN Z11</p>	 <p>I1050 REFORMA ARRANQUE DIPRA MITSUBISHI CANTER Z9</p>	 <p>I1051/8 REFORMA ARRANQUE DIPRA Z8 Ø28MM. MITSUBISHI, NISSAN</p>	 <p>I1052 REFORMA ARRANQUE DIPRA NISSAN I1055 REFORMA ARRANQUE DIPRA CAMION ASIATICO Z9</p>
 <p>I1057 REFORMA ARRANQUE DIPRA TOYOTA Z9</p>	 <p>I1058 REFORMA ARRANQUE DIPRA TOYOTA NIPPONNIPPONDENSO Z11 Ø40MM.</p>	 <p>I1060R REFORMA ARRANQUE DIPRA Z12 M. BENZ SUPER TORQUE VIALES</p>	 <p>I1064 REFORMA ARRANQUE DIPRA PARA ARRANQUE 301064 J. DEERE 445 GIRO IZQ.</p>
 <p>I1106/2 REFORMA ARRANQUE DIPRA AN115 MOTOR INDENOR</p>	 <p>I1166 REFORMA ARRANQUE DIPRA TIPO BOSCH MOTOR CUMMINS Z10 Ø32MM</p>	 <p>I1167 REFORMA ARRANQUE DIPRA AN MWM Z9</p>	 <p>I1386 REFORMA ARRANQUE DIPRA SCANIA TIPO BOSCH Z9</p>
 <p>I1469I REFORMA ARRANQUE DIPRA CAV Z10 GIRO IZQ. I1469/10 REFORMA ARRANQUE DIPRA BNG/CAV Z10 DEUTZ I1469/11 REFORMA ARRANQUE DIPRA AN115 Z11</p>	 <p>I1469 REFORMA ARRANQUE DIPRA PARA ARRANQUE 301470/301469 Z9 I1470 REFORMA ARRANQUE DIPRA AN FIAT SOMECA Z9</p>	 <p>I1470R REFORMA ARRANQUE DIPRA AN FIAT SOMECA Z9 REFORZADO</p>	 <p>I1471 REFORMA ARRANQUE DIPRA AN115 FIAT U.25</p>
 <p>I1472 REFORMA ARRANQUE DIPRA AN FIAT 411</p>	 <p>I1780 REFORMA ARRANQUE DIPRA AN 115 FIAT 780</p>	 <p>I1780R REFORMA ARRANQUE DIPRA AN115 FIAT 780 Z17 (RECTOS) Ø57.5MM.</p>	 <p>I1782R REFORMA ARRANQUE DIPRA FIAT Z12 DIENTES REFORZADO</p>

TAPAS DE SOLENOIDE

 <p>CS1001/1 TIPO APACHE /DELCO REMY</p>	 <p>CS1002/1 DUNA, SAVEIRO, BWM</p>	 <p>CS1003 TIPO INDIEL M93, FORD MWM</p> <p>CS1003/1 AN FORD DIESEL</p>	 <p>CS1004 TIPO DAIHATSU</p> <p>CS1004/1 TIPO DAIHATSU</p>
 <p>Cs1005 ARRANQUE T. MOTORCRAFT / FORD</p> <p>CS1005/1 T. MOTORCRAFT / FORD</p>	 <p>CS1006 FIAT 600</p> <p>CS1006/1 FIAT 600 C/HOJAL</p>	 <p>CS1007 FIAT 1500</p>	 <p>CS1008 RENAULT TS, GOL D.</p> <p>CS1008/1 RENAULT TS 1400</p>
 <p>CS1009 TAUNUS FRONTAL</p> <p>CS1009/1 FORD TAUNUS</p>	 <p>CS1011 TIPO INDIEL M93 SIERRA, RENAULT, VW, FIAT, PEUGEOT</p> <p>CS1011/1 FRONTAL CHICO</p>	 <p>CS1011F TIPO INDIEL FORD ESCORT C/IGNICION</p>	 <p>CS1011G TIPO INDIEL GOL, SAVEIRO S/IGNICION</p>
 <p>CS1011W TIPO INDIEL VW, GOL, GACEL</p>	 <p>CS1017 TIPO TRIA GACEL</p> <p>CS1017/1 TIPO TRIA GACEL</p>	 <p>Cs1018 ARRANQUE RASTROJERO MICARTA</p>	 <p>CS1019 TIPO TRIA DODGE 1500</p>
 <p>CS1022/1 ARRANQUE TIPO INDIEL AN115 24V TIPO AN 115 (PICADILLO)</p>	 <p>CS1022B/1 TIPO AN 115 24V. BAQUELITA</p>	 <p>CS1023 ARRANQUE T. INDIEL AN115 12V. ARMADA</p> <p>CS1023/1 ARRANQUE T. INDIEL AN115 12V.</p>	 <p>CS1024 TIPO INDIEL CHEVROLET, FORD</p>
 <p>CS1029 ARRANQUE TIPO M. MARELLI FIAT</p>	 <p>CS1030 ARRANQUE TIPO ARGELITE RENAULT 9</p>	 <p>CS1034 TIPO TIPO INDIEL TIPO AN115 24V. REFORZADA</p>	 <p>CS1034B ARMADA ARRANQUE TIPO INDIEL AN115 24V. (BAQUELITA)</p>

TAPAS DE SOLENOIDES

 <p>CS1035 ARRANQUE TIPO VALEO RENAULT, PEUGEOT</p>	 <p>CS1044 ARRANQUE TIPO INDIEL RENAULT, PEUGEOT</p>	 <p>CS1045 TIPO BOSCH / NASHVILLE M. BENZ (BAQUIELITA)</p>	 <p>CS1047 ARRANQUE TIPO WAPSA GOL DIESEL, MOTOR MWM, SENDA</p>
 <p>CS1057 M. BENZ SUPER TORQUE</p>	 <p>Cs1065 ARRANQUE TIPO DELCO REMY</p>	 <p>CS1068 ARRANQUE TIPO BOSCH IGNICION C/TERMINA</p>	 <p>CS1069 ARRANQUE TIPO BOSCH C/ENCHUFE</p>
 <p>CS1078/1 TIPO HITACHI / INDIEL CON ENCHUFE</p>	 <p>CS1079/1 TIPO HITACHI / INDIEL</p>	 <p>CS1084/1 TIPO HITACHI / INDIEL CON ENCHUFE</p>	 <p>CS1085/1 TIPO TIPO DELCO REMY 28MT</p>

REPARACIONES Y CONTACTOS DE SOLENOIDES

 <p>C3006 REPARACION AUTOMATICO 12V.</p>	 <p>C3007 REPARACION AUTOMATICO 24V.</p>	 <p>C3011 CONTACTO MOVIL SOLENOIDE DE ARRANQUE TRIA (Cant. 1)</p>	 <p>C3070 REPARACION SOLENOIDE FIAT</p>
 <p>C3071 REPARACION SOLENOIDE INDIEL - RENAULT</p>	 <p>C3072 REPARACION SOLENOIDE TAUNUS</p>	 <p>C3073 REPARACION SOLENOIDE RASTROJERO TIPO INDIEL</p>	 <p>C3074 REPARACION SOLENOIDE TIPO TAMATEL</p>

REPARACIONES Y CONTACTOS DE SOLENOIDES

<p>C3080 REPARACION SOLENOIDE RENAULT 11</p>	<p>C3095 ARRANQUE TIPO NIPPONNIPPON- DENSO 2,4/4KW (Cant. 2) Agujero: 8mm.</p>	<p>C3096 ARRANQUE TIPO NIPPONNIPPON- DENSO 2,5/4KW (Cant. 2) Agujero: 12mm.</p>	<p>C3097 ARRANQUE T. NIPPONNIPPONDENSO 1/1-2/2-2,5/4KW (Cant. 2) Agujero: 10mm.</p>
<p>C3098 ARRANQUE TIPO NIPPONNIPPON- DENSO 1/1,2KW (Cant. 2) Agujero: 8mm.</p>	<p>C3099 ARRANQUE TIPO NIPPONNIPPON- DENSO 2,4/4KW (Cant. 2) Agujero: 8mm.</p>	<p>C3100 ARRANQUE TIPO NIPPONNIPPON- DENSO 20/45MM. (Cant. 2) Agujero: 10mm.</p>	<p>C3101 ARRANQUE TIPO NIPPONNIPPONDENSO 2,5/4KW (Cant. 2) Agujero: 10mm.</p>
<p>C3102 ARRANQUE TIPO NIPPONNIPPON- DENSO 2,5KW (Cant. 2) Agujero: 10mm.</p>	<p>C3104 ARRANQUE TIPO NIPPONNIPPON- DENSO 1,2/1,4KW (Cant. 2) Agujero: 8mm.</p>	<p>C3105 ARRANQUE TIPO NIPPONNIPPON- DENSO 1,1/1,2KW (Cant. 2) Agujero: 8mm.</p>	<p>C3106 ARRANQUE TIPO NIPPONNIPPON- DENSO 1,2/1,4KW (Cant. 2) Agujero: 10mm.</p>
<p>C3107 ARRANQUE TIPO NIPPONNIPPON- DENSO 2,5/4KW (Cant. 2) Agujero: 8mm.</p>	<p>C3108 ARRANQUE TIPO NIPPONNIPPON- DENSO 1,0KW (Cant. 2) Agujero: 8mm.</p>	<p>C3109 ARRANQUE TIPO NIPPONNIPPON- DENSO 1,2KW (Cant. 2) Agujero: 8mm.</p>	<p>C9114 PUENTE TIPO INDIEL RENAULT, PEUGEOT 14X33X2MM. (Cant. 1)</p>
<p>C9115 PUENTE TIPO GAREF FIAT 14X33X2MM. (Cant. 1)</p>	<p>C9116 PUENTE TIPO INDIEL AN 24V. 15,5X43X2,5MM. (Cant. 1)</p>	<p>C9117 PUENTE TIPO INDIEL FORD TAUNUS FRONTAL 14,5X37X2MM. (Cant. 1)</p>	<p>C9118 PUENTE TIPO INDIEL AN 115 12V. 15,5X43X2MM. (Cant. 1)</p>
<p>C9120 PUENTE TIPO INDIEL FRONTAL MOD. NUEVO 14X37X2MM. (Cant. 1)</p>			

PISTONES DE SOLENOIDE

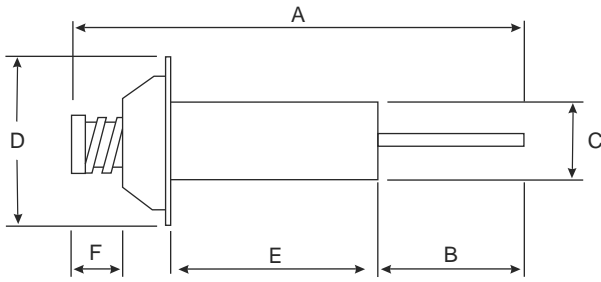

P8130
TIPO NIPPONNIPPONDENSO,
ISUZU, TOYOTA, LUV, MAZDA

- A: 96,0
- F: 8,4
- B: 36,5
- D: 36,8
- C: 20,6
- E: 37,0



P8131
TIPO NIPPONNIPPONDENSO,
ISUZU, C ELICA, CORO

- A: 96,6
- F: 5,5
- B: 39,2
- D: 35,0
- C: 20,6
- E: 37,5



P8131L
TIPO NIPPONNIPPONDENSO
TOYOTA 24V.

- A: 125,3
- F: 5,5
- B: 68,0
- D: 35,0
- C: 20,6
- E: 37,5



P8132
TIPO NIPPONNIPPONDENSO

- A: 124,6
- F: 7,7
- B: 64,6
- D: 36,8
- C: 20,6
- E: 37,0



P8133
TIPO NIPPONNIPPONDENSO

- A: 119,4
- F: 20,0
- B: 41,0
- D: 39,7
- C: 20,6
- E: 44,0



P8135
ATIPO NIPPONNIPPONDENSO

- A: 116,2
- F: 20,0
- B: 40,0
- D: 40,2
- C: 20,6
- E: 42,5



P8230
TIPO NIPPONNIPPONDENSO,
LUV, NISSAN, TOYOTA, ISUZU

- A: 119,4
- F: 20,0
- B: 43,0
- D: 39,7
- C: 20,6
- E: 41,0

REGISTROS DE SOLENOIDE

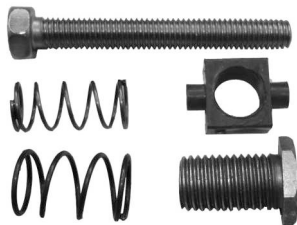

R2113
REGISTRO SOLENOIDE INDENOR



R2114
REGISTRO SOLENOIDE RENAULT



R2115
REGISTRO SOLENOIDE FRONTAL
FORD, ETC.



R2116
REGISTRO SOLENOIDE
RENAULT 1400



R2164
TAPON REGISTRO AUTOMATICO
ARRANQUE TIPO INDIEL,
RENAULT, PEUGEOT, ETC.



T2151
TORNILLOS REGISTRO
AUTOMATICO TIPO INDIEL,
RENAULT, PEUGEOT

SALIDAS Y MALLAS DE ARRANQUE



S1005
BORNE DE MASA ARRANQUE BNG
(Cant. 1)

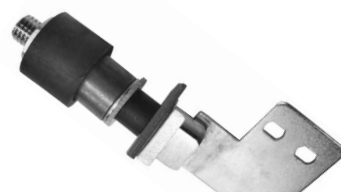

S1023
BORNE DE POTENCIA ARRANQUE
BNG CURVO COMPLETO (Cant. 1)



S1025
JUEGO DE ARANDELAS
PRENSACABLE ARRANQUE
TIPO INDIEL AN 115 24V. (Cant. 1)



S1102
BORNE DE POTENCIA ARRANQUE
BNG RECTO COMPLETO (Cant. 1)

SALIDAS Y MALLAS DE ARRANQUE



S1105
MALLA SOLENOIDE ARRANQUE
TIPO BOSCH EJD, RASTROJERO



S1107
MALLA COMPLETA SOLENOIDE
ARRANQUE TIPO BOSCH EJD,
RASTROJERO



S1112
JUEGO DE ARANDELAS
PRENSACABLE ARRANQUE
TIPO INDIEL AN 115 12V.



S1113
PUENTE COBRE ARRANQUE
CHEVROLET, FALCON



S1121
SALIDA DE CAMPO INDENOR
16MM.



S1122
SALIDA DE CAMPO RENAULT,
PEUGEOT 10MM.



S1124
SALIDA DE CAMPO PEUGEOT,
RENAULT

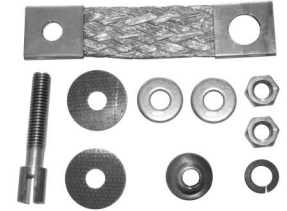

S1126
MALLA ARRANQUE WAPSA GOL,
SENDA, ETC.



S1127
SALIDA DE CAMPO ARRANQUE
TIPO BOSCH M. BENZ, ETC.

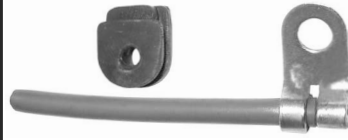

S1129
SALIDA DE CAMPO ARRANQUE
TIPO GAREF

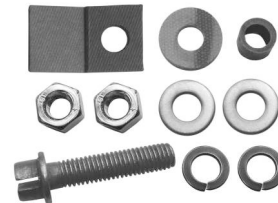

S1131
TORNILLO SALIDA POSITIVO
ARRANQUE TIPO INDIEL, IKA,
FORD, CHEVROLET



S1201
JUEGO DE CONEXION PARA
BORNE 50 ARRANQUE FKB
(Cant. 1)

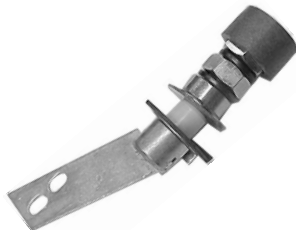

S1205
BORNE DE POTENCIA ARRANQUE
TIPO BOSCH FKB (Cant. 1)



S1207
BORNE DE POTENCIA NEGATIVO
ARRANQUE TIPO BOSCH, FKB
(Cant. 2)

BUJES CENTRADORES



B6100
ARRANQUE FIAT 11X8.5X11MM.



B6101
ARRANQUE TIPO BOSCH
12X9X11MM.



B6102
ARRANQUE RENAULT
10X13X12MM.

BUJES VARIOS



B5646
BUJE CUBREIMPULSOR 101016 /
101044 / 101430 / 101469 -
Z9 34.50X44X42MM. C/PESTAÑA



B5647
BUJE CUBREIMPULSOR 101469/
10 - Z10 Y Z11 40X44.06X30MM.

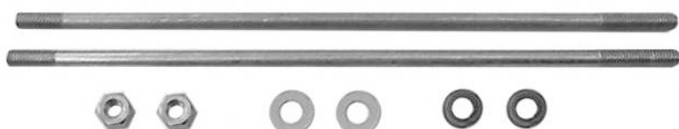

B5905
BUJE CUBREIMPULSOR 101470 -
Z9 35X39.10X41.3MM.

TORNILLOS PASANTES DE ARRANQUE

T2003
ARRANQUE TIPO BOSCH JF M. BENZ, FIAT, DEUTZ M6X212MM.
(Cant. 2)



T2004
ARRANQUE TIPO BOSCH FKB M6X246MM. -M6X196MM. (Cant. 3+1)



T2006
ARRANQUE TIPO TRIA, DODGE 1/4X124MM. (Cant. 2)

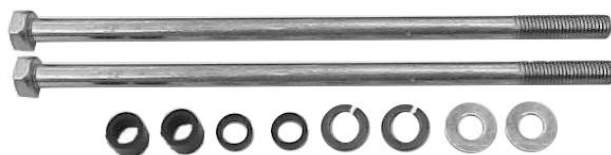

T2017
ARRANQUE TIPO INDIEL AN 115, PERKINS, PEUGEOT DIESEL
LIGERO, FIAT W5/16X185MM. (Cant. 2)

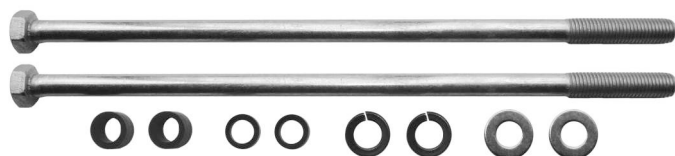

T2018
ARRANQUE TIPO INDIEL AN 115, M. BENZ, PERKINS, FIAT,
DEUTZ W5/16X222MM. (Cant. 2)



T2031
ARRANQUE TIPO BOSCH BNG M6X168MM. CABEZA HEXAGONAL
(Cant. 4)



T2032
ARRANQUE TIPO BOSCH BNG DOBLE ROSCA M6X180MM. (Cant. 4)

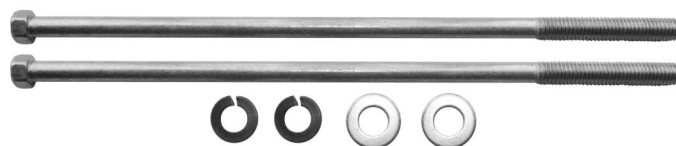

T2123
ARRANQUE TIPO BOSCH, IME, RASTROJERO MOTOR INDENOR Y
BORGWARD M6X168MM. CABEZA HEXAGONAL (Cant. 2)



T2188
ARRANQUE TIPO GAREF FIAT 1500/1600 M6X193MM. CABEZA
MARTILLO (Cant. 2)

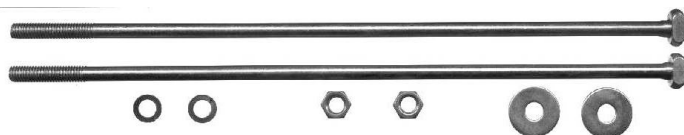

T2189
ARRANQUE TIPO GAREF FIAT 128/DUNA/UNO, PEUGEOT,
DODGE 1500 M5X188MM. CABEZA MARTILLO (Cant. 2)

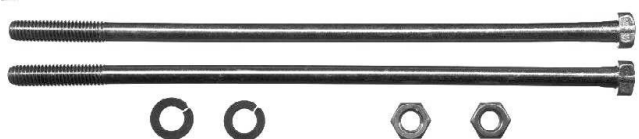

T2190
ARRANQUE TIPO GAREF FIAT 1600 M6X166MM. CABEZA MARTILLO
(Cant. 2)

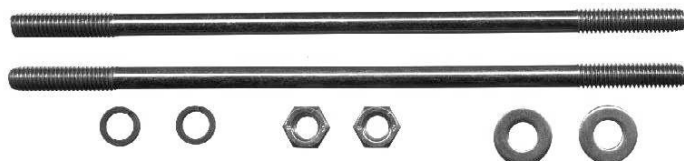

T2191
ARRANQUE TIPO GAREF FIAT 125, DOBLE ROSCA M6X158MM.
(Cant. 2)

TORNILLOS PASANTES DE ARRANQUE

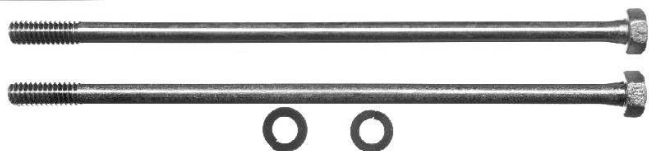

T2192
ARRANQUE TIPO INDIEL, GAREF, IKA, FORD,
CHEVROLET W1/4X160MM. (Cant. 2)



T2194
ARRANQUE TIPO GAREF, INDIEL, DUCCELL, FIAT 600, RENAULT,
PEUGEOT M5X153MM. (Cant. 2)

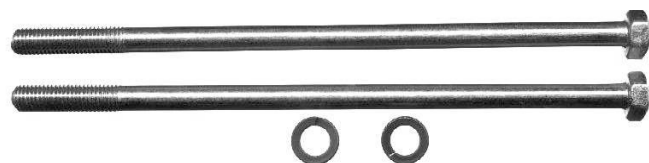

T2196
ARRANQUE TIPO INDIEL RENAULT 4/6/12/18, PEUGEOT 504/405,
FIAT M7X150MM. (Cant. 2)

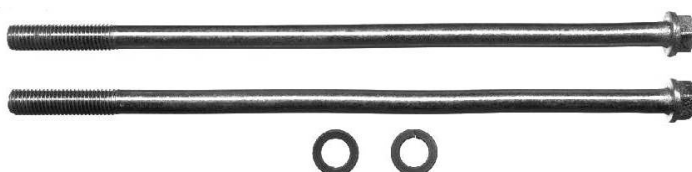

T2197
ARRANQUE TIPO INDIEL M100, TORINO M7X170MM. (Cant. 2)



T2198
ARRANQUE TIPO INDIEL M100, FORD FALCON, F100,
FIAT 125 M7X150MM. (Cant. 2)

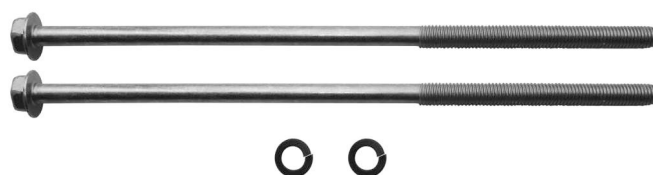

T2199
ARRANQUE TIPO INDIEL FRONTAL M93, PEUGEOT, VW, FIAT,
FORD M5X142MM. (Cant. 2)

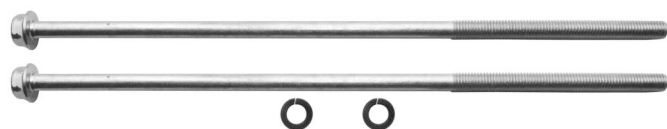

T2200
ARRANQUE TIPO INDIEL M93 FRONTAL, RENAULT 11/19 M5X166MM.
(Cant. 2)

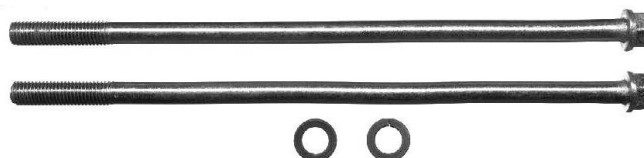

T2203
ARRANQUE TIPO BOSCH INDIEL, HITACHI M74 VARIOS M5X125MM.
CABEZA HEXAGONAL (Cant. 2)

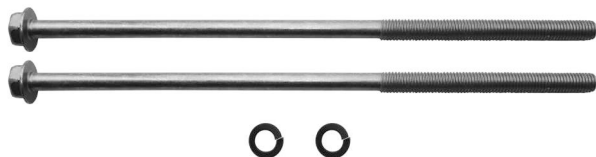

T2206
ARRANQUE TIPO BOSCH M5X125MM. CABEZA HEXAGONAL (Cant. 2)



T2207
ARRANQUE TIPO BOSCH, DOBLE ROSACA M5X160MM. (Cant. 2)



T2211
ARRANQUE TIPO BOSCH M5x160MM. CABEZA HEXAGONAL (Cant. 2)

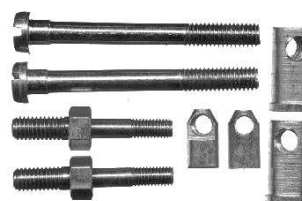

T2215
KIT ARRANQUE TIPO BOSCH / WAPSA, GOL DIESEL, SENDA DIESEL,
SAVEIRO DIESEL (Cant. 1)

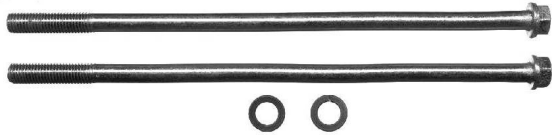
TORNILLOS PASANTES DE ARRANQUE

T2217
ARRANQUE TIPO INDIEL M93R CON REDUCCION M6X140MM.
(Cant. 2)

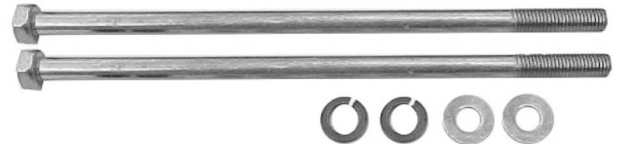

T2218
ARRANQUE TIPO DELCO REMY MT28 - NIPPONNIPPONDENSO
M6X185MM. (Cant. 2)

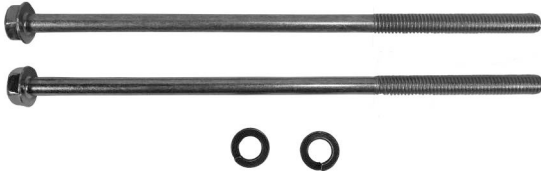

T2219
ARRANQUE TIPO INDIEL / PRESTOLITE M100R M6X145MM. (Cant. 2)

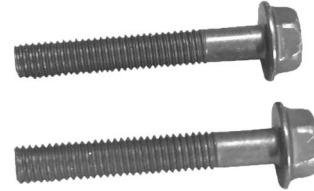

T2220
ARRANQUE TIPO VALEO M5X32MM. CABEZA EXAGONAL (Cant. 2)

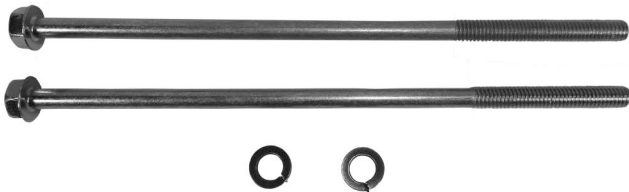

T2221
ARRANQUE TIPO DELCO REMY 29MT M6X154MM. (Cant. 2)



T2222
ARRANQUE TIPO MOTORCRAFT, FORD COURRIER, ETC. (Cant. 2)

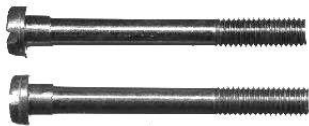

T2223
ARRANQUE TIPO BOSCH M5X116MM. CABEZA HEXAGONAL
CON ARANDELAS (Cant. 2)

TORNILLOS SUJETA SOLENOIDE

T2212
ARRANQUE TIPO BOSCH /
WAPSA LADO CUBREIMPULSOR
SAVEIRO DIESEL, GOL DIESEL
M6X56MM. CABEZA CILINDRICA
(Cant. 2)



T3066
ARRANQUE TIPO INDIEL DOBLE
ROSCA Y TUERCAS (Cant. 4)



T3067
ARRANQUE TIPO INDIEL DOBLE
ROSCA (Cant. 2)



T3110
ARRANQUE TIPO BOSCH JF,
M. BENZ, DEUTS, PERKINS,
FIAT M5X40MM. (Cant. 3)



T3111
ARRANQUE TIPO INDIEL AN 115,
M. BENZ, FIAT, PERKINS,
PEUGEOT, DEUTZ, M6X25MM.
(Cant. 2)



T3116
ARRANQUE TIPO INDIEL
MODELO VIEJO, PERKINS,
FIAT NF 1/4X44MM. (Cant. 2)



T3168
ARRANQUE TIPO INDIEL
FRONTAL M93, RENAULT,
PEUGEOT, SIERRA, FORD,
FIAT M5X42MM. (Cant. 3)

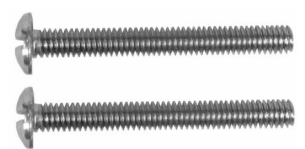

T3170
ARRANQUE TIPO VALEO,
PEUGEOT, RENAULT M4X34MM.
(Cant. 2)

TORNILLOS SUJETA SOLENOIDE



T3171
ARRANQUE TIPO FORD
M6X38MM. (Cant. 2)



T3172
ARRANQUE TIPO TIPO VALEO
TRILOBULAR M4X34MM. (Cant. 2)



T3205
ARRANQUE TIPO BOSCH
RENAULT, FORD, FIAT, VW,
CHEVROLET M5X33MM. (Cant. 3)



T3216
ARRANQUE TIPO INDIEL
FRONTAL, FORD MOTOR,
MWM M5X48MM. (Cant. 3)

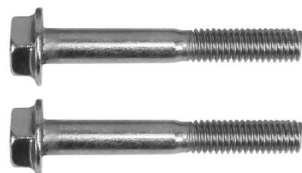

T3219
ARRANQUE TIPO HITACHI,
INDIEL M93R M6X44MM.
CABEZA HEXAGONAL (Cant. 2)

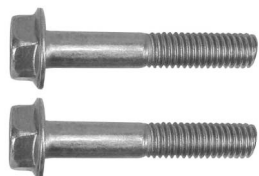

T3220
ARRANQUE TIPO HITACHI,
INDIEL M74R M6X35MM. CABEZA
HEXAGONAL (Cant. 2)

TORNILLOS MASA POLAR

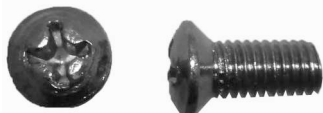

T1133
ARRANQUE BPD, FKB TIPO
BOSCH M8X20MM. (Cant. 8)



T1134
ARRANQUE TIPO BOSCH
RASTROJERO EJD M10X15MM.
(Cant. 4)



T1135
ARRANQUE TIPO INDIEL AN
115 M100R M10X18MM. (Cant. 4)



T1136 ARRANQUE TIPO DELCO Remy 3/8X19MM. (Cant. 8)
T1136/12 ARRANQUE TIPO DELCO Remy 3/8X19MM. (Cant. 12)



T1137
ARRANQUE TIPO INDIEL
AN 115, CAV 3/8X17MM. (Cant. 4)



T1138
ARRANQUE TIPO AUTOLITE
3/8X21MM. (Cant. 4)



T1139
ARRANQUE TIPO DELCO Remy
PASO FINO 24 HILOS 3/8X16MM.
(Cant. 8)



T1140
ARRANQUE TIPO BOSCH,
BNG M10X19MM. (Cant. 4)



T1141
ARRANQUE TIPO GAREF
FIAT 600/128 M10X1.25X9.5MM.
(Cant. 4)



T1142
ARRANQUE TIPO INDIEL, IKA,
FORD, CHEVROLET 3/8X17MM.
(Cant. 4)



T1143
ARRANQUE TIPO TAMATEL,
PEUGEOT M8X12MM. (Cant. 4)



T1144
ARRANQUE TIPO
ELECTROMETALICA,
PEUGEOT 8X16MM. (Cant. 4)



T1145
ARRANQUE TIPO INDIEL FORD
M100/M93, RENAULT, PEUGEOT
M10X14MM. (Cant. 4)



T1146
ARRANQUE FIAT TRACTOR
411 M10X1.25X17MM. (Cant. 4)



T1147
ARRANQUE TIPO LUCAS, SIAM
DI TELLA, MORRIS 3/8X14MM.
(Cant. 4)



T1148
ARRANQUE TIPO GAREF,
FIAT 1500 M10X1.25X14MM.
(Cant. 4)

TORNILLOS MASA POLAR

 <p>T1152 ARRANQUE TIPO TRIA, DODGE 150 3/8X17MM. (Cant. 4)</p>	 <p>T1153 ARRANQUE TIPO TRIA, DODGE POLARA 3/8X14MM. (Cant. 4)</p>	 <p>T1155 ARRANQUE TIPO WAPSA, GOL SENDA, SAVEIRO D, 24 HILOS 3/8X16MM. (Cant. 4)</p>	 <p>T1156 ARRANQUE TIPO BOSCH JF, M. BENZ, DEUTZ, FIAT M10X17.5MM. (Cant. 4)</p>
 <p>T1172 ARRANQUE TIPO DELCO REMY 3/8X19MM. (Cant. 4)</p>	 <p>T1175 ARRANQUE TIPO BOSCH, VW, RENAULT, PEUGEOT M10X8,9MM. (Cant. 4)</p>	 <p>T1176 ARRANQUE TIPO VALEO CARCAZA DE CHAPA M8X12MM. (Cant. 4)</p>	 <p>T1177 ARRANQUE TIPO DELCO REMY MT28 M10X8.9MM. (Cant. 4)</p>
 <p>T1178 ARRANQUE TIPO DELCO REMY 28MT W3/8X15.30MM. (Cant. 4)</p>	 <p>T1179 ARRANQUE TIPO DELCO REMY 28MT M10X1,5MM. (Cant. 4)</p>	 <p>T1180 ARRANQUE TIPO DELCO REMY 28MT M10X1,5MM. (Cant. 4)</p>	 <p>T1181 ARRANQUE TIPO TIPO VALEO LARGO M8X13MM. CABEZA Ø15.5MM. (Cant. 4)</p>
 <p>T1182 ARRANQUE TIPO TIPO INDIEL M93R/M100, FORD, RENALT M10X19MM. CABEZA Ø14MM. (Cant. 4)</p>	<div data-bbox="710 1433 901 1489" data-label="Section-Header"> <p>VARIOS</p> </div>		
 <p>T1213 MILIMETRICOS SURTIDOS ARRANQUE BNG TIPO BOSCH (Cant. 50)</p>	 <p>T2150 TAPA INTERMEDIA ARRANQUE TIPO INDIEL IKA, FORD (Cant. 10)</p>	 <p>F1249 FRENO ARRANQUE RENAULT, PEUGEOT TIPO INDIEL (Cant. 10)</p>	

INDUCIDOS



321000
ARRANQUE TIPO INDIEL AN115 24V.

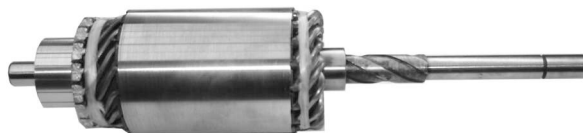

321101
AN 115 LARGA 12V



321102
AN 115 CORTA 12V



321103
AN PEUGEOT DIESEL
LIGERO 12V

321104
TIPO DIESEL LIGERO 24V.
ESPECIAL, FIAT 411 LINEA ASIATICA

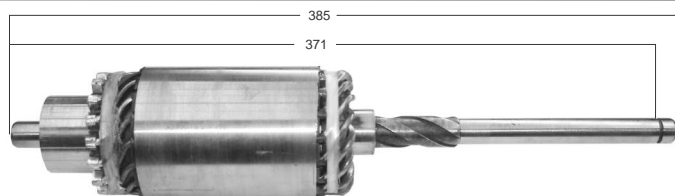

321109
REFORMA SOMECA AN 115 12V. EJE SUPER LARGO (GIRO
DERECHO, ARR 301469)

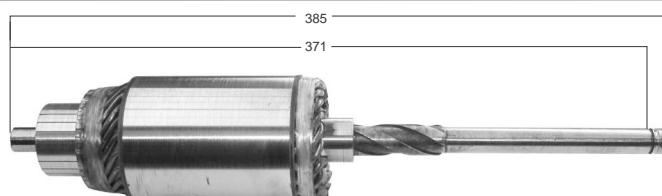

321110
REFORMA SOMECA AN 115 24V. EJE SUPER LARGO
(ARRANQUE 301469/24)

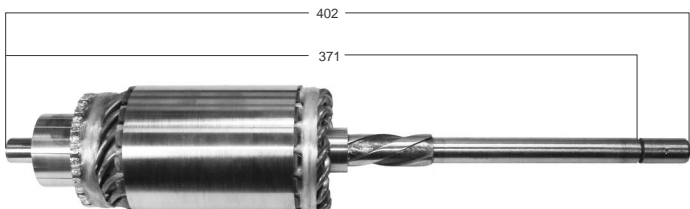

321111
REFORMA AN 115 12V. EJE SUPER LARGO GIRO IZQ.
(ARRANQUE 301469I)



321122
AN 115 CORTA GIRO IZQ. 12V. FIAT U25

KIT REPARACION ARRANQUE



K1007
TIPO AINDIEL M100 FRONTAL FALCON



K1020
TIPO TIPO BOSCH JF BRASIL, M. BENZ - DEUTZ - FIAT

K1040
AN 115 LARGO

K1040/1
AN 115 CORTO











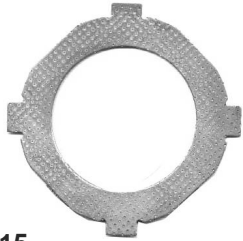
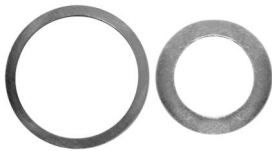

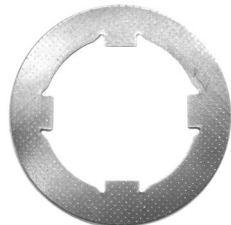



K1040/2
AN 115 LARGO 24V.

K1040/3
AAN DIESEL LIGER

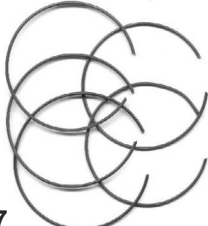
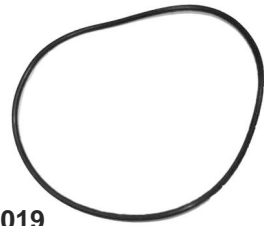
K1040/4
AAN 115 M. BEN



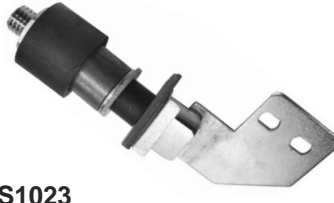









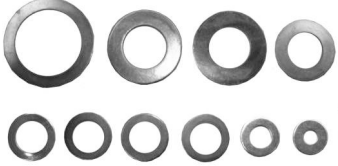



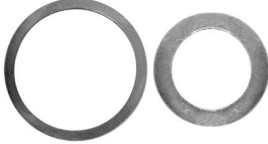





DESPIECE ARRANQUE BNG

 <p>A1015 ARANDELAS DE BRONCE EMBRAGUE BNG (Cant. 3)</p>	 <p>A1022 ARANDELAS DE HIERRO EJE Y PIÑON ARRANQUE BNG (Cant. 20 - 10c/u)</p>	 <p>A1024 ARANDELAS DE PUNTA EJE ARRANQUE BNG GRUESA 12.5X21X2MM. (Cant. 10)</p>	 <p>A1026 ARANDELAS DE HIERRO EMBRAGUE BNG (Cant. 5)</p>
 <p>A1029 ARANDELA ESPESOR EMBRAGUE BNG (Cant. 1)</p>	 <p>A2018 ARANDELA DE MICARTA EMBRAGUE 38.5X55X3.5MM. (Cant. 1)</p>	 <p>A4040 ARANDELA DE FIBRA PERNO GUIA 16,7X31X1,5MM. (Cant. 10)</p>	 <p>BNG1001 PERNO GUIA RECTIFICADO (Cant. 1)</p>
 <p>BNG1008 DISCO LEVANTA GATILLO (Cant. 1)</p>	 <p>E4028 EJE TENSOR COMPLETO ARRANQUE BNG (Cant. 1)</p>	 <p>E5020 ARANDELA COMPENSACION EMBRAGUE ARR. BNG 47X68X0.20MM. (Cant. 10)</p>	 <p>E5021 ARANDELA DE CHOQUE EMBRAGUE BNG 22.4X67X1.6MM. (Cant. 1)</p>
 <p>E5022 RESORTES CONICOS DE EMBRAGUE ARRANQUE BNG (Cant. 20)</p>	 <p>G1017 AROS RETEN ARANDELAS EMBRAGUE ARRANQUE BNG (Cant. 5)</p>	 <p>G1019 JUNTA DE GOMA GUARDAPOLVO ARRANQUE TIPO BOSCH BNG (Cant. 1)</p>	 <p>G2003 JUEGO RETEN DE PIÑON ARRANQUE BNG (Cant. 5)</p>
 <p>G2004 TAPA RETEN PIÑON ARRANQUE BNG (Cant. 1)</p>	 <p>P2041 PORTAESCOBILLAS ARRANQUE TIPO BOSCH, BNG ANCHO - 12X20X28.5MM. (Cant. 1)</p>	 <p>S1005 BORNE DE MASA ARRANQUE BNG (Cant. 1)</p>	 <p>S1023 BORNE DE POTENCIA ARRANQUE BNG CURVO COMPLETO ARRANQUE BNG</p>
 <p>S1102 BORNE DE POTENCIA ARRANQUE BNG RECTO COMPLETO ARRANQUE BNG (Cant. 1)</p>	 <p>T9034 JUEGO TUERCAS DE BOBINA ARRANQUE BNG (Cant. 1)</p>		











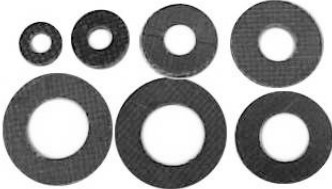
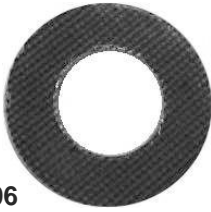

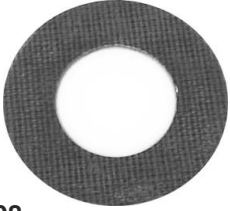
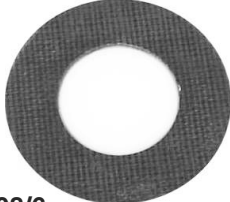



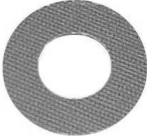

DESPIECE ARRANQUE FKB

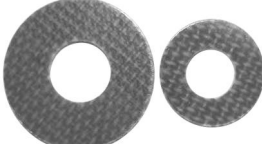
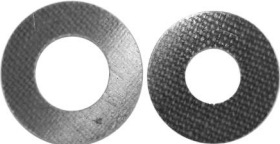
 <p>A1094 ARANDELAS SEGURO IMPULSOR ARRANQUE TIPO BOSCH, FKB (Cant. 10)</p>	 <p>A1095 TUERCA Y SEGURO EJE TENSOR ARRANQUE TIPO BOSCH, FKB (Cant. 1)</p>	 <p>A1107 SUPLEMENTO ENTRE BUJE Y RULEMAN ARRANQUE TIPO BOSCH FKB 36.3X48X1MM. (Cant. 5)</p>	 <p>C2091 CHAVETA CAMPANA ARRANQUE TIPO BOSCH, FK (Cant. 1)</p> <p>C2092 CHAVETA CAMPANA ARRANQUE TIPO BOSCH, FKB (Cant. 10)</p>
 <p>C2093 CHAVETA PLANA ARRANQUE FKB LADO PIÑO (Cant. 1)</p>	 <p>E4016 EJE TENSOR LARGO ARRANQUE FKB 324MM. (Cant. 1)</p>	 <p>E4016M EJE TENSOR MEDIANO ARRANQUE FKB 306MM. (Cant. 1)</p>	 <p>E4016C EJE TENSOR CORTO ARRANQUE FKB 290MM. (Cant. 1)</p> <p>E5063B ARANDELA EMBRAGUE EXTERIOR BRONCE ARRANQUE FKB (Cant. 1)</p>
 <p>E5064 AARANDELAS DE CALIBRACION ARRANQUE FK (Cant. 3)</p>	 <p>E5066 ARANDELAS ELASTICAS DE EMBRAGUE ARRANQUE FKB (Cant. 3)</p>	 <p>Kb1053 TAPA CIERRE DE CAMPANA ARRANQUE TIPO BOSCH, FKB (CANT. 1)</p>	 <p>S1201 JUEGO DE CONEXION PARA BORNE 50 ARRANQUE FKB (Cant. 1)</p>
 <p>S1205 BORNE DE POTENCIA ARRANQUE TIPO BOSCH FKB (Cant. 1)</p>	 <p>S1207 BORNE DE POTENCIA NEGATIVO ARRANQUE TIPO BOSCH, FKB (Cant. 1)</p>	 <p>T1241 EJUEGO DE ESPARRAGOS SUJETA SOLENOIDE ARRANQUE FK (Cant. 2)</p>	 <p>802072 TAPA GUARDA POLVO ARRANQUE FKB (2.000. 580.121) (Cant. 1)</p>

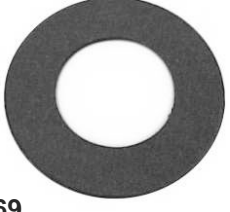

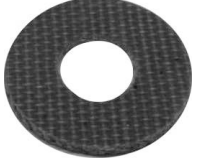







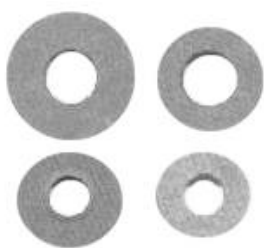
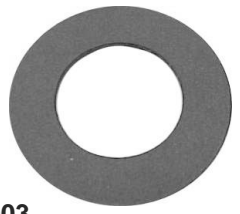



ARANDELAS DE HIERRO

 <p>A1007 LADO COLECTOR BOSCH JF, INDIEL, IKA, M. BENZ EJE 2X30X0.5 Y 1MM. (Cant. 20)</p>	 <p>A1012 SURTIDAS (Cant. 100)</p>	 <p>A1016 17 x 30 x 1MM. (Cant. 20)</p>	 <p>A1017 BENDIX IKA 21.4X32X1MM. (Cant. 20)</p>
 <p>A1019 INDUCIDO ARRANQUE CHEV/FALCON 16.1X28X5MM. (Cant. 20)</p>	 <p>A1021 LADO COLECTOR ARRANQUE TIPO INDIEL M9 (Cant. 20)</p>	 <p>A1022 EJE Y PIÑÓN ARRANQUE BNG (Cant. 20 - 10 c/u)</p>	 <p>A1024 PUNTA EJE ARARNQUE BNG GRUESA 12.5X21X2MM. (Cant. 10)</p>
 <p>A1025 LADO COLECTOR ARRANQUE NASHVILLE, BOSCH EJD 14X25X05 Y 1MM. (Cant. 20)</p>	 <p>A1029 ESPESOR EMBRAGUE BNG (Cant. 1)</p>	 <p>A1036 LADO COLECTOR INDIEL, GAREF, BOSCH 12.2X20X0.5 Y 1MM. (Cant. 20)</p>	 <p>A1037 TAPA INTERMEDIA AN115 CHEVROLET / FORD 26.5X35X0.5 Y 1MM. (Cant. 20)</p>
 <p>A1041 SUPLEMENTO POLEAS ALTERNADOR 17X33X2MM. (Cant. 10)</p>	 <p>A1057 LADO COLECTOR ARRANQUE FIAT 600 11X16X1 Y 1.5MM. (Cant. 20)</p>	 <p>A1077 LADO COLECTOR INDIEL 16X29X1 Y 0.5MM. (Cant. 20)</p>	 <p>A1078 EJE Y PIÑÓN ARRANQUE FKB 22.5X26,5X0,3MM. (Cant. 10)</p>
 <p>A1107 SUPLEMENTO ENTRE BUJE Y RULEMAN ARRANQUE TIPO BOSCH FKB 36.3X48X1MM. (Cant. 5)</p>	 <p>A3080 CON TRABA LADO COLECTOR ARRANQUE TIPO BOSCH JF (Cant. 10)</p>	 <p>E5020 COMPENSACION EMBRAGUE ARRANQUE BNG 47X68X0.20MM. (Cant. 10)</p>	 <p>E5021 CHOQUE EMBRAGUE BNG 22.4X67X1.6MM. (Cant. 1)</p>
 <p>F1053 DOBLE PESTAÑA, FRENO ARRANQUE TIPO INDIEL M93 (Cant. 10)</p>	 <p>F1150 SUPLEMENTO DE FRENO RASTROJERO, M. BENZ TIPO BOSCH/EJD 19.5X39X1MM. (Cant. 20)</p>	 <p>F1159 TOPE LADO COLECTOR RASTROJERO (Cant. 1)</p>	

ARANDELAS MICARTA

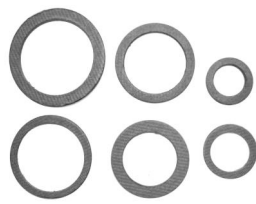
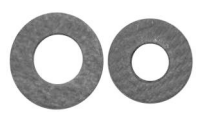
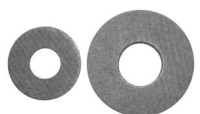

 <p>A2001 EJE BOBINA 16X30X1MM. (Cant. 10)</p>	 <p>A2005 SURTIDAS (Cant. 100)</p>	 <p>A2006 LADO COLECTOR ARRANQUES VARIOS 13X25.5X1 Y 2MM. (Cant. 20 - 10 c/u)</p>	 <p>A2007 LADO COLECTOR INDIEL AN115 ´ 15X29X1 Y 2MM. (Cant. 20 - 10 c/u)</p>
 <p>A2007/6 LADO COLECTOR INDIEL AN115 15X29X1 Y 2MM. (Cant. 6 - 3 c/u)</p>	 <p>A2008 LADO COLECTOR INDIEL - BOSCH JF - M. BENZ 16X30.5X1 Y 2MM. (Cant. 20 - 10 c/u)</p>	 <p>A2008/6 LADO COLECTOR INDIEL - BOSCH JF - M. BENZ 16X30.5X1 Y 2MM. (Cant. 6 - 3 c/u)</p>	 <p>A2009 19.2X35.5X1 Y 2MM. (Cant. 20 - 10 c/u)</p>
 <p>A2009/6 35X19 X1 Y 2MM. (Cant. 6 - 3 c/u)</p>	 <p>A2010 LADO COLECTOR ARRANQUE INDIEL - GAREF - BOSCH 12X19X1MM.(Cant. 20)</p>	 <p>A2022 LADO COLECTOR NASHVILLE - BOSCH EJD 29X14X1 Y 2MM. (Cant. 20 - 10 c/u)</p> <p>A2022/6 LADO COLECTOR NASHVILLE - BOSCH EJD 29X14X1 Y 2MM. (Cant. 6 - 3 c/u)</p>	 <p>A2023 COLECTOR FIAT 600 10X19X1MM. (Cant. 20)</p>
 <p>A2024 LADO COLECTOR ARRANQUES VARIOS, FRENO INDIEL M93 11X19X1MM. (Cant. 20)</p>	 <p>A2064 4X8X1MM. (Cant. 10)</p>	 <p>A2065 6X13X1 Y 6.5X15X1MM. (Cant. 20 - 10 c/u)</p>	 <p>A2066 8X16 Y 10.2X20X1MM. (Cant. 20 - 10 c/u)</p>
 <p>A2067 12.8X25.5X1 Y 2MM. (Cant. 6 - 3 c/u)</p>	 <p>A2069 LADO COLECTOR INDIEL - BOSCH JF - IKA 16.8X31X1 Y 2MM. (Cant. 6 - 3 c/u)</p>	 <p>A2081 5X16X1 Y 2MM. (Cant. 20 - 10 c/u)</p>	 <p>A2082 INTERIOR PLAQUETA DIODOS 6.2X16X1MM. (Cant. 20 - 10 c/u)</p>
 <p>A2083 INTERIOR PLAQUETA DIODOS 6.5X8.5X2MM. (Cant. 20)</p>	 <p>A2084 INTERIOR PLAQUETA DIODOS 12X8X2MM. (Cant. 20)</p>	 <p>A2085 SEPARADOR DIODOS TIPO NASHVILLE 10X2X1MM. (Cant. 20)</p>	

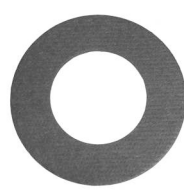
ARANDELAS FIBRA

 <p>A4002 SURTIDAS (Cant. 150)</p>	 <p>A4003 EJE BOBINA ARRANQUE TRIA 32X19MM. (Cant. 10)</p>	 <p>A4040 PERNO GUIA 16,7X31X1,5MM. (Cant. 10)</p>	 <p>A4041 12,8X25X1MM. (Cant. 25)</p>
 <p>A4042 15,9X30X1MM. (Cant. 25)</p>	 <p>A4043 17X31X1MM. (Cant. 25)</p>	 <p>A4044 17X31X1MM. (Cant. 25)</p>	 <p>A4045 10X14MM. (Cant. 20)</p>
 <p>A4046 12X17MM. (Cant. 20)</p>	 <p>A4047 14X20MM. (Cant. 20)</p>	 <p>A4048 16X21MM. (Cant. 20)</p>	 <p>A4049 18X22MM. (Cant. 20)</p>
 <p>A4050 20X26MM. (Cant. 20)</p>	 <p>A4051 8X12MM. (Cant. 20)</p>	 <p>A4054 SURTIDAS ESPECIAL (ALA ANGOSTA) (Cant. 100)</p>	 <p>A4058 3,2X7,5MM. Y 4,1X8X1MM. (Cant. 20 - 10 c/u)</p>
 <p>A4059 4,7X13MM. Y 6,3X16X1MM. (Cant. 20 - 10 c/u)</p>	 <p>A4060 8,2X16,2X1MM. Y 9,5X19X1MM. (Cant. 20 - 10 c/u)</p>	 <p>F1149F FRENO EJD BOSCH BRASIL 35X20X1MM. (Cant. 10)</p>	

ARANDELAS ALUMINIO

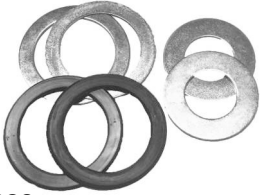
 <p>A8003 SURTIDAS (Cant. 100)</p>	 <p>A8005 8X13MM. (Cant. 10)</p>	 <p>A8006 10X14MM. (Cant. 10)</p>	 <p>A8007 12X17MM. (Cant. 10)</p>
 <p>A8008 14X20MM. (Cant. 10)</p>	 <p>A8009 16X21MM. (Cant. 10)</p>	 <p>A8010 18X23MM. (Cant. 10)</p>	 <p>A8011 20X26MM. (Cant. 10)</p>
 <p>A8012 22X28MM. (Cant. 10)</p>	<p>ARANDELAS PLASTICAS</p>		

 <p>A7020 SUPLEMENTO BOBINA ARR. AN115 (NYLON Y HIERRO) LADO COLEC. Y BUJE INTERMEDIO (Cant. 6 - 2 c/u)</p>	 <p>A7020P NYLON ARRANQUE AN115 BUJE INTERMEDIO (Cant. 30)</p>	 <p>A7056 NYLON ARRANQUE IKA 17X32X1-1.5 Y 2MM. (Cant. 9 - 3 c/u)</p>	 <p>A7076 NYLON ARRANQUE INDIEL FRONTAL22X8X5MM. (Cant. 10)</p>